

COMANCHE-40ER

NIGHT VISION CLIP-ON SYSTEM

USER MANUAL

© 2023 AGM Global Vision, LLC. All rights reserved.

This documentation is subject to change without notice.

No parts of this manual, in whole or in part, may be copied, photocopied, translated, or transmitted by any electronic medium or in machine-readable form without the prior written permission of AGM Global Vision, LLC.

If you have questions that are not covered in this manual, or need service, contact AGM Global Vision customer support for additional information prior to returning a product.

AGM Global Vision, LLC

173 West Main Street

PO Box 962

Springerville, AZ 85938

Tel. 928.333.4300

support@agmglobalvision.com

www.agmglobalvision.com

EXPORT INFORMATION

Buyer acknowledges that all products supplied by AGM Global Vision, LLC are subject to U.S. export control laws, including, but not limited to, the Export Administration Regulations, the International Traffic in Arms Regulations, the International Economic Emergency Powers Act, and various U.S. embargoes and sanctions. AGM Global Vision products may not be exported, re-exported, or transferred contrary to U.S. export control laws. In particular, AGM Global Vision products may not be exported, re-exported, or transferred to prohibited countries, individuals, organizations, or entities, including but not limited to those individuals and entities listed on the List of Specially Designated Nationals and Blocked Persons administered or maintained by the U.S. Office of Foreign Assets Control ("OFAC"), the various lists maintained by the Bureau of Industry and Security of the Department of Commerce, and the U.S. State Department and Buyer represents and warrants that neither Buyer nor any of its officers, directors, or employees are on such lists. Distribution or resale by Buyer to such countries, individuals, organizations, or entities is expressly prohibited. Buyer has and will maintain a positive process to ensure compliance with this Section.

LIST OF CONTENTS

TITLE	PAGE
Safety Summary	4
SECTION 1. GENERAL INFORMATION	6
1.1 General Information	6
1.2 Key Features	6
1.3 System Description	6
1.4 Standard Components	8
1.5 Optional Equipment	9
SECTION 2. OPERATING INSTRUCTIONS	10
2.1 Installation and Mounting	10
2.2 Controls and Indicators	14
2.3 Operating Procedures	15
SECTION 3. MAINTENANCE	17
3.1 Cleaning Procedures	17
3.2 Troubleshooting	17
SECTION 4. WARRANTY INFORMATION	19
4.1 Warranty Information	19
4.2 Limitation of Liability	19
4.3 Product Registration	20
4.4 Obtaining Warranty Service	20
SECTION 5. SPECIFICATIONS	21
5.1 Specifications	21

SAFETY SUMMARY

- Read and follow all instructions
- Read all warnings
- Only use the attachments/accessories specified by the manufacturer
- All service must be provided by the manufacturer

WARNING:

Always make sure your firearm is unloaded before you place the scope on the firearm. Verify that the chamber is empty, particularly if you stop the procedure and resume at a later time. Safe handling rules should be followed at all times.

WARNING:

If a scope is mounted too far to the rear of a weapon, the eyepiece can injure the shooter's brow. Shooting at an uphill angle also increases this risk, because it shortens the distance between the brow and the rear of the scope. When mounting your scope, we recommend positioning it as far forward in the mounts as possible.

With hard-recoiling rifles, serious injury or even death can result from eyepiece impact when discharging the firearm.

BEFORE SHOOTING THE FIREARM, verify that your installation provides sufficient space between the eyepiece and the scope to account for the recoil generated by your rifle.

NOTE: Give special attention to this warning when shooting uphill and/or from a prone position. These shooting conditions can dramatically reduce space allotted for recoil between your eyes and the weapon. PLEASE maintain maximum distance when shooting magnum firearms or firearms with heavy recoil. THE USER ASSUMES ALL RESPONSIBILITY AND LIABILITY FOR HAVING THE RIFLESCOPE PROPERLY MOUNTED TO A FIREARM AND USING THE RIFLESCOPE PROPERLY. ALWAYS CHECK THE CONDITION OF YOUR MOUNTING SYSTEM PRIOR TO USING YOUR FIREARM.

WARNING:

This product contains natural rubber latex which may cause allergic reactions! The FDA has reported an increase in the number of deaths that are associated with an apparent sensitivity to natural latex proteins. If you are allergic to latex, it is a good idea to learn which products contain it and strictly avoid exposure to those products.

WARNING:

- It is recommended that you use an eyecup on the eyepiece of the day scope, allowing for the eyepiece diameter and eye relief and having side paddle preferably in order to escape detection.
- The light from the infrared illuminator is invisible to the unaided eye. However, the light can be detected by other night vision devices.

CAUTION:

- DO NOT dismantle the equipment.
- Keep the equipment clean. Protect it from moisture, dramatic temperature changes, and electric shocks.
- DO NOT drop or hit the equipment.
- Protect the equipment from overexposure to light: DO NOT activate the equipment in daylight with the objective lens cap removed; DO NOT aim the equipment at bright light sources (a fire, car headlights, lanterns, streetlamps, room lights, etc.).
- DO NOT force the equipment controls past their stopping points.
- DO NOT leave the equipment activated during breaks in operation.
- Verify that the equipment is off before installing a battery.
- DO NOT store the equipment with the battery still in it.
- To avoid deformation or damage, remove the light suppressor from the Comanche-40ER before placing the equipment in storage.
- Thoroughly clean and dry each item before placing them into the storage case.
- Scope Mounting Systems are not recommended for installing the Comanche-40ER on firearms having vigorous recoil (0.308 Win or stronger).

NOTES:

- Optical axes of the Comanche-40ER and day scope should align. It is not recommended for the distance between the axes to exceed 3mm. If the difference in the axis heights of the Comanche-40ER and day scope above the weapon rail exceeds 3mm, you will need to replace the day scope mounting rings or monoblock.
- The equipment requires some level of ambient light (moonlight, starlight, etc.) to function correctly.
- Performance of the device in night-time conditions depends on the level of ambient light in the environment. Please remember the following:
 - The level of ambient light is reduced by the presence of clouds, shade, or objects that block natural light (trees, buildings, etc.).
 - The equipment is less effective when operated in shadows and other darkened areas.
 - The equipment is less effective when operated in rain, fog, sleet, snow, dust or smoke.
 - The equipment will not “see” through dense smoke.
- For the purpose of returning defective components, retain all packaging materials.

1 GENERAL INFORMATION

1.1 GENERAL INFORMATION

The AGM Global vision Comanche-40ER Night Vision Clip-On (NVCO) system uses the latest advances in night vision clip-on technology. Designed for mid-range nighttime shooting, the Comanche-40ER delivers exceptional clarity, reliability, and versatility providing the most significant functionality and features at the lowest possible price.

The Comanche-40ER is mounted to a standard Weaver or Picatinny rail in front of an existing day scope; transforming it into a Night Vision Device (NVD) with no re-zeroing required. This NVCO can be used with day scopes of up to 12x magnification for optimal performance and is equipped with a quick release mount and remote control. It provides unmatched target acquisition and enhanced aiming capabilities, making it extremely practical and effective during the most challenging missions.

1.2 KEY FEATURES

- **Simple, quick conversion of daytime scopes to NVDs**
- **Manual gain control**
- **Mounts in front of any daytime scope, no re-zeroing required**
- **Equipped with a wireless remote control**
- **Powered by a single Alkaline 1.5V AA or 3V CR123A Lithium battery**
- **Bright-light cut-off system**
- **Quick-release mount**
- **3-year warranty**

1.3 SYSTEM DESCRIPTION

The Comanche-40ER consists of two primary parts: the night vision device (hereafter referred to as NVD) and the mount. The Comanche-40ER is delivered already assembled with a mount. The mount should be secured to the seating rail of the NVD with two screws.

The NVD includes four main components: the objective and output lenses, an image intensifier tube, and the body.

The objective lens focuses available light (photons) on the photocathode of the image intensifier tube (IIT). The light energy causes electrons to be released from the cathode. After being amplified, the electron flow represents an intensified version of the original image of the scene. The electrons then strike the IIT phosphor screen, which reacts to them by glow that is visible to the human eye. The image is projected by the output lens from the IIT screen to the day scope lens.

The Comanche-40ER incorporates manual gain control, which allows the operator to increase or decrease the brightness of the image to compensate for overly bright or extremely dark conditions. The Comanche-40ER is powered by a single Alkaline 1.5V AA or 3V CR123A Lithium battery. The mount system quick and reliable mounts the Comanche-40ER to the Picatinny/Weaver rail. The Comanche-40ER is shown in Figure 1-1. The ITEM NO. column in Table 1-1 indicates the number used to identify items in Figure 1-1.

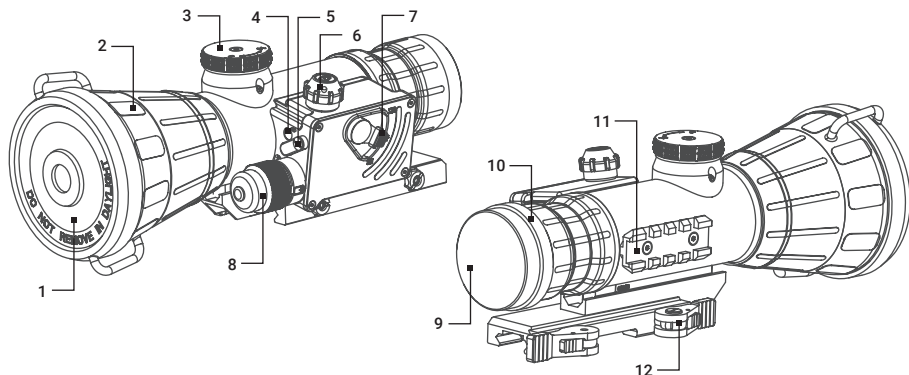

FIGURE 1-1. COMANCHE-40ER NIGHT VISION CLIP-ON MAIN PART

TABLE 1-1. COMANCHE-40ER NIGHT VISION CLIP-ON MAIN PART

ITEM	DESCRIPTION
1	Objective Lens Cap
2	Objective Lens
3	Focus Knob
4	Photoreceiver
5	Pivoted Shutter
6	Gain Control Knob

ITEM	DESCRIPTION
7	Operating Modes Switch
8	Battery Cap with Adapter
9	Output Lens Cap
10	Output Lens
11	Weaver Rail
12	Quick-Release Mount

1.4 STANDARD COMPONENTS

The Comanche-40ER standard components are shown in Figure 1-2 and listed in Table 1-2. The ITEM column indicates the number used to identify items in Figure 1-2.

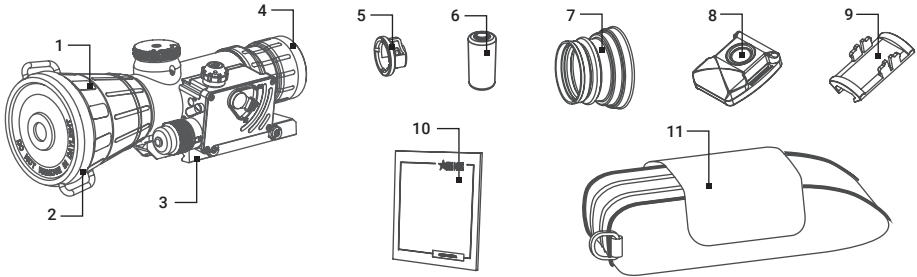

FIGURE 1-2. STANDARD COMPONENTS

TABLE 1-2. STANDARD COMPONENTS

ITEM	DESCRIPTION	QUANTITY
1	Comanche-40ER Night Vision Clip-On	1
2	Lens Cap	1
3	Quick-Release Mount	1
4	Output Lens Cap	1
5	Battery Adapter (installed in the battery cap)	1
6	CR123A Battery	1
7	Light Suppressor	1
8	Remote Control	1
9	Picatinny Adapter for Remote Control	1
10	User Manual	1
11	Carrying Case	1

NOTE:

The mount may differ from that shown in the image.

1.5 OPTIONAL EQUIPMENT

The Comanche-40ER optional equipment are shown in Figure 1-3 and listed in Table 1-3. The ITEM column indicates the number used to identify items in Figure 1-3.

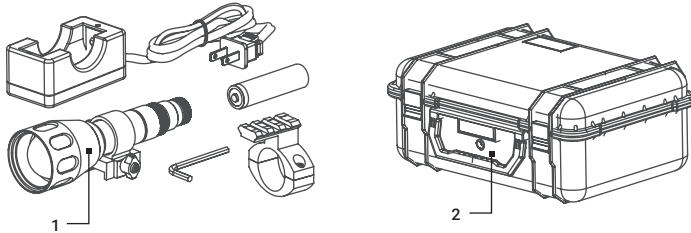

FIGURE 1-3. OPTIONAL EQUIPMENT

TABLE 1-3. OPTIONAL EQUIPMENT

ITEM	DESCRIPTION	PART NO.
1	Sioux850 Long Range Infrared Illuminator (Mount, 18650 Rechargeable Battery, Charger and Platform Ring Adapter are included)	6605C401
2	Hard Case for Storage/Transportation	6610HCS1

2 OPERATING INSTRUCTIONS

2.1 INSTALLATION AND MOUNTING

CAUTION

To protect the image intensifier tube when the device is not in use or when it is being operated in daylight, keep the protective objective lens cap securely fitted over the lens.

2.1.1 COMANCHE-40ER BATTERY INSTALLATION

NOTE:

At operating temperatures below -20°C (-4°F), alkaline battery life will be severely reduced. Under said conditions, the use of lithium battery is recommended.

CAUTION:

Ensure that the device is off before installing the battery.

Install the battery as follows (refer to Figure 2-1):

1. Unscrew the battery cap (A) and check the position of the adapter (B). See Figure 2-1 for the correct positioning of the threaded adapter, which changes depending on the battery being installed.
2. If necessary, change the adapter position in the cap.
2. Install the battery (C) into the battery compartment (D), following the polarity order marked on the compartment for reference (E).
3. Replace the battery cap.

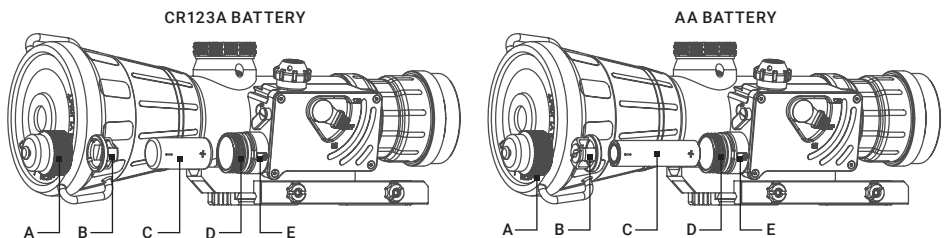

FIGURE 2-1. COMANCHE-40ER BATTERY INSTALLATION

2.1.2 INSTALLING THE COMANCHE-40ER ON A PICATINNY/WEAVER RAIL

WARNING:

When installing the equipment on a weapon, verify that the weapon is clear and that the safety is on before proceeding.

WARNING:

It is recommended that you use an eyecup on the eyepiece of the day scope, allowing for the eyepiece diameter and eye relief and having side paddle preferably in order to escape detection.

NOTE:

The optical axes of the Comanche-40ER and day scope should be aligned. The distance between the axes should not exceed 3 mm. If the difference in the axis heights of the Comanche-40ER and day scope above the weapon rail exceeds 3 mm, you will need to replace the day scope mounting rings or monoblock.

Install the Comanche-40ER on a Picatinny/ Weaver rail in front of a day scope as follows:

1. Remove the output lens cap and place it in the storage case.
2. Install the light suppressor to the output lens in place of the cap.

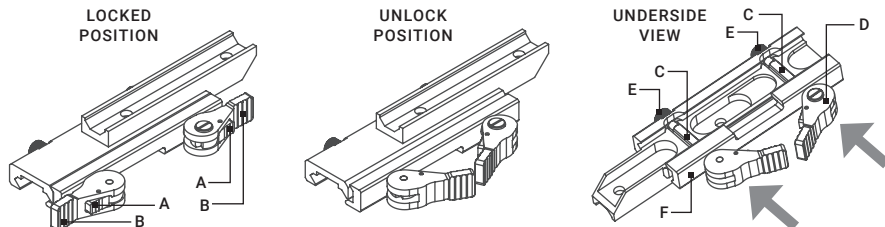

FIGURE 2-2. MOUNT.

3. Unlock the clamping device of the Comanche-40ER mount by pushing down on the lever holder (A, see Figure 2-2) and unlocking the cam lever (B).

NOTE:

The direction of the clamp lever in the closed/open position may differ that shown in the image.

4. Install the Comanche-40ER on the Picatinny/ Weaver rail in front of the day scope so that the stop (C) slides into one of the rail's transverse slots. The light suppressor should cover the day scope's objective lens.
5. Affix the Comanche-40ER to the rail by locking the cam lever (B).
6. Verify that the clamping device is firmly holding the Comanche-40ER. If necessary, adjust the clamping device as detailed below (Clamping Device Adjustment).

Figure 2-3 shows the Comanche-40ER (A) and a day scope (B) installed with the light suppressor (C) on a Picatinny/Weaver rail (D).

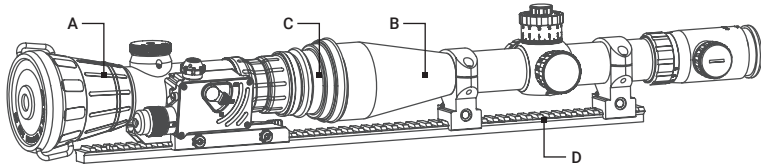

FIGURE 2-3. COMANCHE-40ER ON A PICATINNY RAIL IN FRONT OF A DAY SCOPE

Clamping Device Adjustment

To adjust the mount's clamping device, do the following:

1. Remove the Comanche-40ER from the weapon.
2. With the clamping device unlocked, push the cam (D) towards the arrow, which will cause the nut (E) to slide out of its hole.
3. To tighten/loosen the clamping device (F) turn the nut (E) CW/CCW respectively, in one-two increments (see note below). Much like when the cam (D) is released, backward-moving springs will cause the nut (E) to slide back into its hole.

NOTE:

The eight-sided nuts of the mount lever-cam locks will only fit into their holes if turned in one of the discrete positions, using increments equal to $360^\circ/8$.

4. Verify that the adjusted lever-cam lock securely holds the weapon mounting rail.

2.1.3 FASTENING THE WIRELESS REMOTE CONTROL TO A WEAPON

Using Velcro tape (A), fasten the Wireless Remote Control (B) (Figure 2-4) to your weapon in an easily accessible place (e.g., on the front of the rifle stock) on the side of the Comanche-22's control compartment preferably.

If your rifle has a Picatinny or Weaver rail on the forend you can use the Picatinny adapter for Wireless Remote (C). Install adapter on the rail. Insert the remote control unit in the adapter.

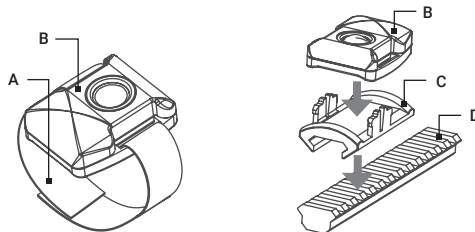

FIGURE 2-4. WIRELESS REMOTE CONTROL

2.1.4 INSTALLING THE OPTIONAL IR ILLUMINATOR

The Sioux850 is delivered ready-assembled with a dedicated mount, to be installed on the Weaver rail.

Mount the Sioux850 as follows (Figure 2-5):

1. With the nut (A) loosened, install the mount (B) on the Weaver rail so that the stop (C) slides into one of the transverse slots of the rail.
2. Tighten the nut (A).

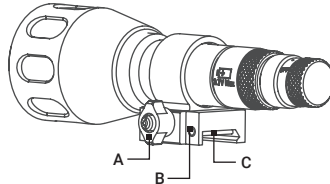

FIGURE 2-5. SIOUX850 IR ILLUMINATOR

Use the optional Platform Ring to install the Sioux850 on the day scope.

The Platform Ring with IR illuminator installed on a day scope is shown in Figure 2-6.

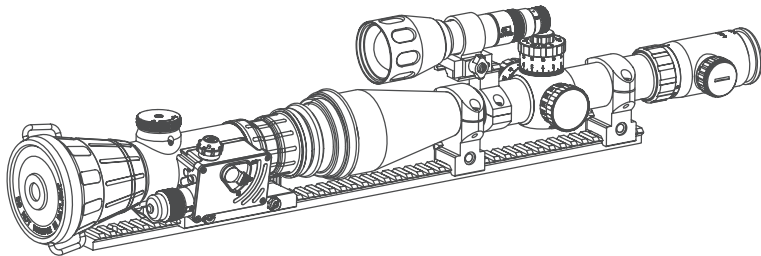

FIGURE 2-6. SIOUX850 IR ILLUMINATOR INSTALLATION

Install the platform ring on the mounting tube of the day scope as follows (refer to Figure 2-7):

1. Using a 3 mm hex key, unscrew the both clamp screws (C).
2. Place the ring's clamps (D, E) onto the scope's mounting tube with/ without the pair of inserts (A), depending on the mounting tube size (25.4/ 30 mm respectively). Screw the clamps together without tightening the screws (C).
3. Adjust position of the platform ring until its Weaver rail (B) is level. Apply a small amount of thread lock to the threads and tighten the screws (C).

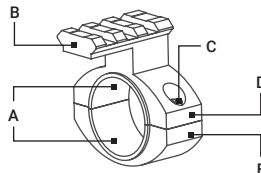

FIGURE 2-7. PLATFORM RING

2.2 CONTROLS AND INDICATORS

CAUTION:

DO NOT force the equipment controls past their stopping points.

2.2.1 COMANCHE-40ER CONTROLS AND INDICATOR

The Comanche-40ER controls and indicator are shown in Figure 2-8 and defined in Table 2-1. The ITEM column indicates the number used to identify items in Figure 2-8.

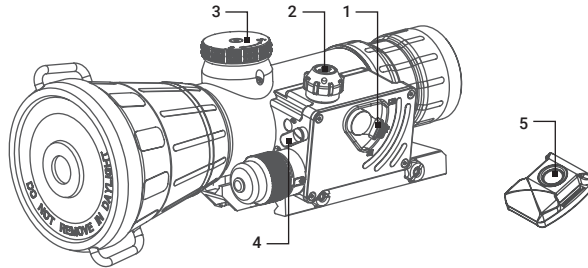

FIGURE 2-8. COMANCHE-40ER CONTROLS AND INDICATOR

TABLE 2-1. COMANCHE-40ER CONTROLS AND INDICATOR

ITEM	CONTROLS/INDICATORS	FUNCTION
1	Operating Modes Switch	Activates the Comanche-40ER, when turned to ON position.
		Activates standby mode, when turned to STB position.
		Deactivates the Comanche-40ER, when turned to OFF position.
2	Gain Control Knob	Adjusts the brightness of the image.
3	Focus Knob	Focuses the objective lens.
4	Pivoted Shutter	Closes/ opens the photoreceiver when placed in the highest/ lowest position.
-	Built-in LED Indicator	PERMANENT GREEN GLOW indicates excessive light conditions. After 10 seconds the image intensifier tube will be cut off. The Comanche-40ER turns back again when moved away from the excessive light.
		PERMANENT RED GLOW indicates usable condition of the battery.
5	Remote Control Button	Activates/deactivates the Comanche-40ER in standby when pressed/released.

2.3 OPERATING PROCEDURES

2.3.1 OPERATING THE COMANCHE-40ER

Operating procedures should be performed in night light conditions only.

CAUTION:

Use of the Comanche-40ER in brightly lit conditions may damage the image intensifier tube.

1. Verify that the battery is installed as required.
2. Remove the objective lens cap and place it over the lens' housing.
3. Verify that there are no bright light sources in the Comanche-40ER's field of view. Turn the device on by rotation the operation switch to the ON position. After a slight delay, a green glow will appear in the day scope's output lens.

CAUTION:

Avoid exposing the device to bright light sources such as firelight, headlights, searchlights, etc., as these can damage the Comanche-40ER.

4. Observe the scene and adjust the focus. Bring the object into focus by turning the objective focus knob. Rotate the focus knob until the subject looks sharp in the viewfinder.
5. Adjust the image brightness. Look into the eyepiece of day scope. Rotate the gain control knob to gradually adjust the brightness until the desired level is reached.
6. If the day scope includes a focusing ring (i.e., parallax adjustment knob), adjust the focus for a parallax free image.
7. Turn on the day scope's reticle illumination and adjust the reticle brightness.
8. To operate the Comanche-40ER using remote control, turn the operation switch to the STB (Standby) position . The remote control can activate/ deactivate the device in two ways:
 - 1) To turn on the device, press the remote control button once. To turn off the device, press the button again.
 - 2) To operate the device in short-time activation mode, press and hold the remote control button for 1.5+ seconds. Release the remote control button to deactivate the device
9. To turned the Comanche-40ER off rotate the operation switch to the fixed OFF position.

CAUTION:

DO NOT leave the Comanche-40ER activated if it is not being used.

2.3.2 SHUT-DOWN

Shut-down the Comanche-40ER as follows:

1. Turn off the device. The glow in viewfinder will disappear.
2. Place the cap over the objective lens.
3. Remove the remote control.
4. Remove the Comanche-40ER from the weapon.
5. Remove the light suppressor from the output lens.
6. Place the protective cap to output lens.

7. Remove the battery from Comanche-40ER.

CAUTION:

DO NOT store the equipment with the battery still in it.

8. Ensure that the Comanche-40ER and any accessories are clean and dry before placing them into the storage case.

9. Place the Comanche-40ER and any accessories into the storage case.

10. Store the Comanche-40ER and accessories in the appropriate locations in the case and close the cover.

3 MAINTENANCE

3.1 CLEANING PROCEDURES

CAUTION:

Thoroughly dry each item before placing them into the storage case.

Clean the Comanche-40ER as follows:

1. Gently brush off any dirt from the device's body using a clean soft cloth.
2. Moisten the cloth with fresh water and gently wipe external surfaces (except for glass surfaces).
3. Dry any wet surfaces (except for glass surfaces) with another clean, soft, dry cloth.
4. Using a lens brush, carefully remove all loose dirt from the glass surfaces.
5. Slightly dampen a cotton swab with ethanol. Gently and slowly wipe the lenses. Without touching the lens holders, clean the glass surfaces in circular movements, beginning in the center and moving out towards the edge. Change the cotton swab after each circular stroke. Repeat until the glass surfaces are clean.
6. Clean the battery surfaces and contacts with a pencil eraser and/or alcohol-dampened cotton swabs.

3.2 TROUBLESHOOTING

The purpose of troubleshooting is to identify the most commonly occurring equipment malfunctions, their probable causes, and the corrective actions required to fix them.

Table 3-1 lists the common malfunctions that may occur during the operation or maintenance of the Comanche-40ER. Perform the tests, inspections, and corrective actions in the order listed in the table.

This table cannot list all of the malfunctions that may occur with your Comanche-40ER, or all of the tests and corrective actions that may be necessary. If you experience an equipment malfunction that is not listed, or is not fixed by the corrective actions listed in the table, please contact Customer Service center.

TABLE 3-1. TROUBLESHOOTING

MALFUNCTION	PROBABLE CAUSE/ TEST/ INSPECTION	CORRECTIVE ACTION
Comanche-40ER fails to activate.	Battery is missing or improperly installed.	Insert battery or install correctly.
	Battery is dead.	Replace the battery.
	Battery surfaces or contacts are dirty or corroded.	Clean the contact surfaces with a pencil eraser and/or alcohol and cotton swabs.
	Defective image intensifier tube.	Please contact Customer Support.
Poor image quality.	Check focus.	Refocus.
	Objective and output lenses are dirty.	Thoroughly clean the surfaces of each lens.
	Damaged optical components.	Please contact Customer Support.
Comanche-40ER affects boresight after installation or during the firing.	Factory alignment is broken.	Please contact Customer Support.
Hindered rotation of the battery cap.	Dirty cap thread.	Clean the thread.
	Damaged cap thread.	Please contact Customer Support.
Battery adapter difficult to remove.	Check for damaged battery adapter and battery cap.	If damaged please contact Customer Support.
Light visible around light suppressor.	Incorrect position of the Comanche-40ER in relation to the day scope.	Reposition the Comanche-40ER on the Picatinny/ Weaver rail.
	Check the light suppressor resilience.	If light suppressor is defective please contact Customer Support.

4 WARRANTY INFORMATION

4.1 WARRANTY INFORMATION

This product is guaranteed to be free from manufacturing defects in material and workmanship under normal use for a period of three (3) years from the date of purchase. In the event that a defect covered by the warranty below occurs during the applicable period stated above, AGM Global Vision, at its discretion, will either repair or replace the product; such action on the part of AGM Global Vision shall be the full extent of AGM Global Vision's liability, and the Customer's sole and exclusive reparation. This warranty does not cover a product if it has been (a) used in ways other than its normal and customary manner; (b) subjected to misuse; (c) subjected to alterations, modifications or repairs by the Customer or by any party other than AGM Global Vision without prior written consent of AGM Global Vision; (d) is the result of a special order or categorized as "close-out" merchandise or merchandise sold "as-is" by either AGM Global Vision or the AGM Global Vision dealer; or (e) merchandise that has been discontinued by the manufacturer and either parts or replacement units are not available due to reasons beyond the control of AGM Global Vision. AGM Global Vision shall not be responsible for any defects or damage that in AGM Global Vision's view are a result from the mishandling, abuse, misuse, improper storage or improper operation of the device, including use in conjunction with equipment that is electrically or mechanically incompatible with, or of inferior quality to, the product, as well as failure to maintain the environmental conditions specified by the manufacturer. This warranty is extended only to the original purchaser. Any breach of this warranty shall be enforced unless the customer notifies AGM Global Vision at the address noted below within the applicable warranty period.

The customer understands and agrees that except for the foregoing warranty, no other warranties written or oral, statutory, expressed or implied, including any implied warranty of merchantability or fitness for a particular purpose, shall apply to the product. All such implied warranties are hereby and expressly disclaimed.

4.2 LIMITATION OF LIABILITY

AGM Global Vision will not be liable for any claims, actions, suits, proceedings, costs, expenses, damages, or liabilities arising out of the use of this product. Operation and use of the product are the sole responsibility of the Customer. AGM Global Vision's sole undertaking is limited to providing the products and services outlined herein in accordance with the terms and conditions of this Agreement. The provision of products sold and services performed by AGM Global Vision to the Customer shall not be interpreted, construed, or regarded, either expressly or implied, as being for the benefit of or creating any obligation toward any third party of legal entity outside AGM Global Vision and the Customer; AGM Global Vision's obligations under this Agreement extend solely to the Customer. AGM Global Vision's liability hereunder for damages, regardless of the form or action, shall not exceed the fees or other charges paid to AGM Global Vision by the customer or customer's dealer. AGM Global Vision shall not, in any event, be liable for special, indirect, incidental, or consequential damages, including, but not limited to, lost income, lost revenue, or lost profit, whether such damages were foreseeable or not at the time of purchase, and whether or not such damages arise out of a breach of warranty, a breach of agreement, negligence, strict liability, or any other theory of liability.

4.3 PRODUCT REGISTRATION

In order to validate the warranty on your product, the customer must complete and submit AGM Global Vision PRODUCT REGISTRATION FORM on our website (www.agmglobalvision.com/customer-support).

4.4 OBTAINING WARRANTY SERVICE

To obtain warranty service on your unit, the End-user (Customer) must notify the AGM Global Vision service department via e-mail. Send any requests to support@agmglobalvision.com to receive a Return Merchandise Authorization number (RMA). When returning any device, please take the product to your retailer, or send the product, postage paid and with a copy of your sales receipt, to AGM Global Vision's service center at the address listed above. All merchandise must be fully insured with the correct postage; AGM Global Vision will not be responsible for improper postage or merchandise that becomes lost or damaged during shipment. When sending product back, please clearly write the RMA# on the outside of the shipping box. Please include a letter that indicates your RMA#, the Customer's Name, a Return Address, reason for the return, contact information (valid telephone numbers and/or an e-mail address), and proof of purchase that will help us to establish the valid start date of the warranty. Product merchandise returns that do not have an RMA# listed may be refused, or a significant delay in processing may occur. Estimated Warranty service time is 10-20 business days. The End-user/Customer is responsible for postage to AGM Global Vision for warranty service. AGM Global Vision will cover return postage/shipping after warranty repair to the End-user/Customer only if the product is covered by the aforementioned warranty. AGM Global Vision will return the product after warranty service by domestic UPS Ground service and/or domestic mail. Should any other requested, required, or international shipping methods be necessary, the postage/shipping fee will be the responsibility of the End-user/Customer.

For service, repair or replacement, please contact:

AGM Global Vision, LLC

173 West Main Street

PO Box 962

Springerville, AZ 85938

Tel. 928.333.4300

support@agmglobalvision.com

www.agmglobalvision.com

5 SPECIFICATIONS

5.1 SPECIFICATIONS

The following tables provide information pertaining to the operational, optical, electrical, mechanical, and environmental characteristics of the Comanche-40ER clip-on system.

TABLE 5-1. OPTICAL DATA

ITEM	DATA
Magnification	1X
Objective Lens Focal Length	108 mm
Objective Lens F/number	1:1.54
Range of Focus	10 m to infinity
Field of View	9°
Exit Pupil Diameter	40 mm

TABLE 5-2. SYSTEM DATA

ITEM	DATA
Remote Controls	Yes (Wireless)
Manual Gain Control	Yes
Low Battery Indicator	Yes
Excessive light Conditions Indicator	Yes
Automatic Shut-Off System	Yes

TABLE 5-3. MECHANICAL DATA

ITEM	DATA
Overall Dimensions (L×W×H)	242 × 100 × 88 mm (9.5 × 3.9 × 3.5 in)
Weight (without Battery)	0.91 kg (2.0 lb)
Height of the Comanche-40ER Optical Axis above Picatinny/ Weaver Rail	40 mm (1.6 in)

TABLE 5-4. ELECTRICAL DATA

ITEM	DATA
Battery	One CR123A (3V) or AA (1.5 V)
Battery Life at 20°C	Up to 40 hrs. (3V)

TABLE 5-5. ENVIRONMENTAL DATA

ITEM	DATA
Operating Temperature	-40 to +50°C (-40 to 122°F)
Storage Temperature	-50 to +50°C (-58 to 122°F)
Illumination Required	Natural night illumination (overcast starlight to moonlight)
Environmental Rating	Water and Fog-Resistant

NOTE:

All data are subject to change without notice.



AGM Global Vision, LLC

MAIN OFFICE

173 West Main Street

PO Box 962

Springerville, AZ 85938

USA

Tel. +1.928.333.4300

info@agmglobalvision.com

www.agmglobalvision.com

EUROPEAN OFFICE

#6 Andrey Lyapchev Blvd

Sofia, P.C. 1756

Bulgaria

Tel. +35.988.560.0326

info@agmglobalvision.eu

www.agmglobalvision.eu

AGMglobalvision.com