

# EVOLVER LRF 1280

THERMAL IMAGING RIFLESCOPE  
WITH LASER RANGEFINDER

USER MANUAL

© 2024 AGM Global Vision, LLC. All rights reserved.

This documentation is subject to change without notice.

No parts of this manual, in whole or in part, may be copied, photocopied, translated, or transmitted by any electronic medium or in machine-readable form without the prior written permission of AGM Global Vision, LLC.

If you have questions that are not covered in this manual, or need service, contact AGM Global Vision customer support for additional information prior to returning a product.

## **AGM Global Vision, LLC**

**173 West Main Street**

**PO Box 962**

**Springerville, AZ 85938**

**Tel. 928.333.4300**

**support@agmglobalvision.com**

**www.agmglobalvision.com**

## **EXPORT INFORMATION**

Buyer acknowledges that all products supplied by AGM Global Vision, LLC are subject to U.S. export control laws, including, but not limited to, the Export Administration Regulations, the International Traffic in Arms Regulations, the International Economic Emergency Powers Act, and various U.S. embargoes and sanctions. AGM Global Vision products may not be exported, re-exported, or transferred contrary to U.S. export control laws. In particular, AGM Global Vision products may not be exported, re-exported, or transferred to prohibited countries, individuals, organizations, or entities, including but not limited to those individuals and entities listed on the List of Specially Designated Nationals and Blocked Persons administered or maintained by the U.S. Office of Foreign Assets Control ("OFAC"), the various lists maintained by the Bureau of Industry and Security of the Department of Commerce, and the U.S. State Department and Buyer represents and warrants that neither Buyer nor any of its officers, directors, or employees are on such lists. Distribution or resale by Buyer to such countries, individuals, organizations, or entities is expressly prohibited. Buyer has and will maintain a positive process to ensure compliance with this Section.

## FCC INFORMATION

Please note that changes or modification not expressly approved by the party responsible for compliance could void the user's authority to operate the equipment.

This equipment complies with FCC/IC RSS-102 radiation exposure limits set forth for an uncontrolled environment.



FCC compliance: This product has been tested and found to comply with the limits for a Class B digital device, pursuant to Part 15 of the FCC Rules. These limits are designed to provide reasonable protection against harmful interference in a residential installation. This product generates, uses, and can radiate radio frequency energy and, if not installed and used in accordance with the instructions, may cause harmful interference to radio communications. However, there is no guarantee that interference will not occur in a particular installation. If this product does cause harmful interference to radio or television reception, which can be determined by turning the equipment off and on, the user is encouraged to try to correct the interference by one or more of the following measures:

- Reorient or relocate the receiving antenna.
- Increase the separation between the equipment and receiver.
- Connect the equipment into an outlet on a circuit different from that to which the receiver is connected.
- Consult the dealer or an experienced radio/TV technician for help.

### FCC Conditions

This device complies with part 15 of the FCC Rules. Operation is subject to the following two conditions:

1. This device may not cause harmful interference.
2. This device must accept any interference received, including interference that may cause undesired operation.

## EU CONFORMITY STATEMENT



This product and - if applicable - the supplied accessories too are marked with "CE" and comply therefore with the applicable harmonized European standards listed under the EMC Directive 2014/30/EU, the RoHS Directive 2011/65/EU



2012/19/EU (WEEE directive): Products marked with this symbol cannot be disposed of as unsorted municipal waste in the European Union. For proper recycling, return this product to your local supplier upon the purchase of equivalent new equipment, or dispose of it at designated collection points. For more information see: [www.recyclethis.info](http://www.recyclethis.info)



Regulation (EU) 2023/1542 (Battery Regulation): This product contains a battery and it is in conformity with the Regulation (EU) 2023/1542. The battery cannot be disposed of as unsorted municipal waste in the European Union. See the product documentation for specific battery information. The battery is marked with this symbol, which may include lettering to indicate cadmium (Cd), or lead (Pb). For proper recycling, return the battery to your supplier or to a designated collection point. For more information see: [www.recyclethis.info](http://www.recyclethis.info).

## INDUSTRY CANADA ICES-003 COMPLIANCE

This device meets the CAN ICES-3 (B)/NMB-3(B) standards requirements.

# LIST OF CONTENTS

TITLE	PAGE
Safety Summary	5
<b>1. GENERAL INFORMATION</b>	<b>7</b>
1.1 System Description	7
1.2 Key Features	8
<b>2. OPERATING INSTRUCTIONS</b>	<b>9</b>
2.1. Basic Operations	9
2.2 Main Function	16
2.3 Client Software Introduction	29
<b>3. MAINTENANCE</b>	<b>30</b>
3.1 Maintenance	30
3.2 Troubleshooting	31
<b>4. WARRANTY INFORMATION</b>	<b>32</b>
4.1 Warranty Information and Registration	32
<b>5. SPECIFICATIONS</b>	<b>34</b>
5.1 Specifications	34
5.2 Reticle Parameters	36

# SAFETY SUMMARY

- Read and follow all instructions
- Read all warnings
- Only use the attachments/accessories specified by the manufacturer
- All service must be provided by the manufacturer

## **WARNINGS:**

- **This product contains natural rubber latex, which may have the potential to cause allergic reactions. If you are allergic to latex, it is important that you strictly avoid exposure to products that contain it.**
- Always make sure your firearm is unloaded before you place the optic on the firearm. Reconfirm that the chamber is empty if you are forced to stop at anytime before completing the zeroing in process. Safe handling rules should be followed at all times.
- If a scope is mounted too far to the rear, the eyepiece may cause an impact injury to the shooter's eye socket. Shooting at an uphill angle also increases this hazard because it shortens the distance between the eyebrow and the rear of the scope. For this reason, AGM scopes are engineered to provide generous eye relief. Therefore, when mounting your scope, we recommend positioning it as far forward in the mounts as possible to take full advantage of this generous eye relief. With hard-recoiling rifles, serious injury or even death can result from eyepiece impact with the shooter during the recoil process when discharging the firearm. Be certain that your installation provides sufficient eye relief for the recoil generated by your rifle before shooting the firearm.

## **NOTES:**

Give special attention to this warning when shooting uphill and/or from a prone position. These shooting conditions can dramatically reduce eye relief. PLEASE maintain maximum eye relief when shooting heavy recoiling and/or magnum firearms. THE USER ASSUMES ALL RESPONSIBILITY AND LIABILITY FOR HAVING THE AGM RIFLE SCOPE PROPERLY MOUNTED TO A FIREARM AND USING THE AGM RIFLE SCOPE PROPERLY. ALWAYS CHECK THE CONDITION OF YOUR MOUNTING SYSTEM PRIOR TO USING YOUR FIREARM.

- Proper usage of the device is crucial for safe operation, so make sure to carefully read this manual.
- If the device was left in storage for a longer period of time, before use, check its functionality.
- Disassembling of the device is prohibited and will invalidate the product warranty. Disassembly of any kind should only occur at AGM repair facilities.
- The external optical surfaces should be clean at all times. Touching the optical surfaces with bare hands is not recommended.
- Sand and sea water can damage the optical coatings.
- Do not point the device directly at the sun as it may damage the display.

- Thermal imagery is highly dependent on different scenery and atmospheric conditions. The same scenery may differ slightly in its appearance to the user, based on the time of day or night the optic is being used. This is the result of the level of heat absorption of different objects, which will vary based on the sun's placement in the sky at the time of use. The contrast of live animals will be more evident depending on the difference in surrounding air temperature and humidity levels.
- It is always recommended to store the unit with battery removed, when not in use. Recharging the batteries every 2-3 months will help to extend their charging reliability.
- It is recommended to store the device with the lens cap closed at all times.
- Occasionally, extreme temperature shifts may cause condensation to form on the outer germanium lens. In this scenario, use a soft cloth to gently wipe the lens clean. As the unit becomes acclimates to the outer temperature, condensation should dissipate.

#### **NOTES:**

- The detector spectral band provides better visibility through smoke, dust, rain, smog, etc.
- Infrared radiation does not travel through glass. As a result, the rifle scope does not detect objects if they are behind glass windows or other barriers.

#### **LASER CAUTION:**

When any laser equipment is in use, make sure that the device lens is not exposed to the laser beam, or it may burn out. The laser radiation emitted from the device can cause eye injuries, burning of skin or inflammable substances. Before enabling the light supplement function, make sure no human or inflammable substances are in front of the laser lens. Do not place the device where minors can fetch it. According to IEC 60825 1:2014, EN 60825 1:2014+A11:2021, and EN 50689:2021, this laser product is classified as Class 1 laser product and consumer laser product.

Complies with FDA performance standards for laser products except for conformance with IEC 60825-1 Ed. 3., as described in Laser Notice No.56, dated May 8, 2019.



# 1 GENERAL INFORMATION

## 1.1 SYSTEM DESCRIPTION

The AGM Evolver LRF 1280 is now the new apex predator in the field. Providing an unrivaled image quality in compact housing, the Evolver LRF is equipping it with a 65mm germanium lens and a 1280x1024 resolution thermal sensor. Not only that, but it's been paired with a fully integrated 1,000m laser rangefinder and AGM's new on-board ballistic calculator. A newly designed eyepiece gives the Evolver a very versatile 2.5X base magnification, which can then be digitally zoomed up to 20X on the high end. This means hog hunters will enjoy a base magnification low enough for close range engagements, while predator hunters can comfortably zoom to 5X while still enjoying a crisp 640 resolution before zooming further. AGM's powerful new imaging algorithm and new semi-circular display give shooters a feeling of precision and sophistication. Large sturdy buttons were designed to aid gloved fingers in cold winter weather, while the removable rechargeable NE-4400 battery offers current and future AGM customers one of the most robust and easy to install battery systems on the market. And of course, a full firmware package has been incorporated to allow users an astonishing level of customization: on-board pitch scale, 10 brightness and contrast settings, warm & cold viewing modes, multiple color palettes, manual focus, picture in picture, ballistic calculation, on-board video recording with sound, 1,000m laser range finding, WiFi hotspot, multiple zeroing profiles, shot activated video recording, defective pixel repair, hotspot locator and multiple laser range finding modes. Also included is an American-made ADM mounting system.

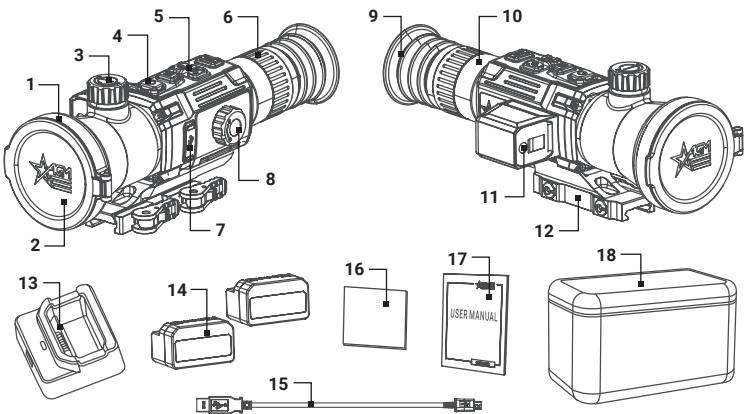

FIGURE 1-1. MAIN PARTS AND COMPONENTS

**TABLE 1-1. MAIN PARTS AND COMPONENTS**

ITEM	DESCRIPTION	ITEM	DESCRIPTION
1	Lens	10	Eyepiece
2	Lens Cover	11	Laser Range Finder
3	Lens Focusing Knob	12	Mount
4	Power Button	13	NE-4400 Charger
5	Operation Buttons	14	NE-4400 Li-Ion Battery (2)
6	Diopter Adjustment Ring	15	USB Cable
7	USB Type-C Interface	16	Lens Tissue
8	Battery Compartment	17	User Manual
9	Eyecup	18	Carrying Case

## 1.2 KEY FEATURES

- 12 micron detector with 1280x1024 resolution
- Sub-18mK thermal sensitivity
- Built-in 1,000m laser rangefinder
- Various reticle types and colors
- Ballistic calculator
- 1x, 2x, 4x, 8x digital zoom
- Large OLED display with 2560x2560 resolution
- On-board video/audio recording and image capture
- Shot Activated Recording (SAR) function
- Built-in EMMC storage (64 GB)
- Wi-Fi data transmission
- Standby mode
- More than 4 hours of battery life
- External power supply compatibility
- Waterproof & shockproof
- ADM quick release mounting system



## 2 OPERATING INSTRUCTIONS

### 2.1. BASIC OPERATIONS

#### 2.1.1 UNPACKING

The following steps must be completed prior to each use.

1. Open the carrying case, remove the device, and verify that all components are included.
2. Inspect the device for any signs of damage to the optical surfaces, body, eyecup, operation buttons, etc. Ensure that all optical surfaces are clean and ready for use. Once the diopter is set, all focusing of the image upon use of the digital zoom will occur via the lens focus knob, which is the rotating knob closest to the objective lens of the scope.

#### 2.1.2 BATTERY INSTRUCTION

1. The device supports a removable NE-4400 Li-Ion rechargeable battery. The battery voltage is 3.6V and the capacity is 4.4Ah (15.84 Wh). The battery charging voltage is limited to 4.2V.
2. Before first use, charge the battery to full capacity using the NE-Charger. You can also charge the battery installed in the device using an external 5V/2A power adapter via the scope's USB port.
3. Be sure to remove the battery when storing the device for long periods of time.

#### 2.1.3 BATTERY INSTALLATION

##### **CAUTION:**

Verify that the device is turned off before removing the battery.

To install the battery (refer to Figure 2-1):

1. Turn the battery cover knob (A) counter clockwise and then open the battery cover (B).

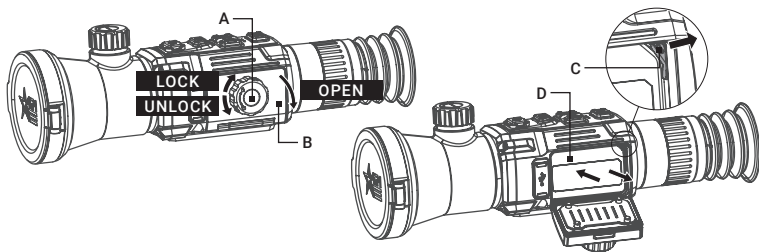

FIGURE 2-1. BATTERY INSTALLATION

2. Push the red latch (C) aside (as the arrow shows), and release the battery.
3. Insert the battery (D) into the battery compartment. The latch locks the battery in place when the battery is fully inserted.
4. Once the battery is locked into place, close the battery door until a “click” is heard, or felt. This means the internal battery door lever is engaged with the housing to secure the battery door in place.

## 2.1.4 CONTROL BUTTONS

The Evolver controls are shown in Figure 2-2 and are defined in Table 2-1. Each button is responsible for some functions selected by short press or long press of the button. Pushing a button for 3+ second is considered “long press/hold.”

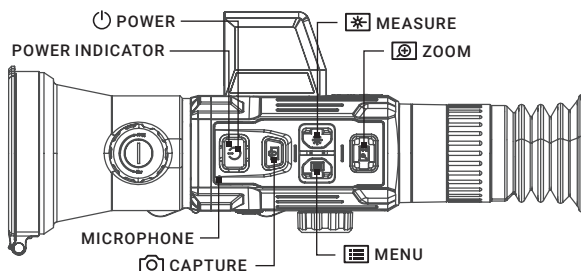







FIGURE 2-2. CONTROL BUTTONS

TABLE 2-1. BUTTON FUNCTIONS

BUTTON	FUNCTIONS
 POWER	Press: Standby Mode/Wake Up Device Long Press: Power On/Off
 MENU	Press: Palette Switching Hold: Enter the Main Menu <b>MENU MODE</b> Press: Confirm/Set Parameters Long Press: Exit the Menu
 LRF	Press: Turning on the Laser / Distance Measurement Double Press: Turning Off the Laser Long Press: Image Calibration (FFC)
 CAPTURE	Press: Image Capture Long Press: Start/Stop Video Recording <b>MENU MODE</b> Press: Up/Change Parameters
 ZOOM	Press: Switching Digital Zoom Long Press: Enable/Disable PIP Mode <b>MENU MODE</b> Press: Down/Change Parameters

## 2.1.5 POWER ON AND OFF

### Power On

With the battery installed, press and hold the POWER button to turn on the device. The LED power indicator in the POWER button will light up.

### Power Off

When the device is turned on, hold the POWER button  to turn off the device.



### Auto Power Off

In the “Auto Power Off” submenu of General Settings you can set the time for the automatic shutdown of the device as required (see 2.2.30 for details).

The Auto Power Off countdown will start again when the device exits standby mode, or the device is restarted.

## 2.1.6 STANDBY MODE

Standby mode is used to save battery power. In this mode, some power-consuming features such as the display, network hardware, or internal storage will be temporarily disabled.

In the view mode, press the POWER button . After a few seconds, the display will turn off. Press the POWER button  again to exit the Standby mode.

## 2.1.7 VIEWING THE THERMAL IMAGE

1. Power on the rifle scope.
2. Open the lens cover, bring the scope to your eye and make sure the eyecup covers your eye. The internal display will show the thermal image and on-screen interface.
3. Use the diopter adjustment ring (rotating ring closest to your eye) to ensure that the on-screen interface elements are crisp and sharp. Once completed, this adjustment will not be needed again until a new user is using the device.
4. Once the diopters are set, all image focusing for various distances will occur using the lens focusing knob, which is located on the top of the scope.

### NOTE:

You must perform the focus adjustment before any further use of the scope.

5. Set palette, brightness, contrast, tone, and scene mode to display the best image effect.

## 2.1.8 ON-SCREEN DISPLAY

On-screen interface displays the menu items and device status indicators.

Use the MENU button  in the view mode to display or hide the menu.

Adjust the On-Screen Display (OSD) in the Function Settings menu (see 2.2.20). When OSD is on, the information of Shot Activated Recording (SAR) function, Wi-Fi hotspot activation, storage memory status, battery status, current magnification setting, time and date displays on the screen.

The screen can also display the reticle, recommended aiming point, LRF mark, current zeroing profile, zeroing distance, distance measurement result, drop distance and the pitch scales. You can configure the display of all these elements in the scope's menu.

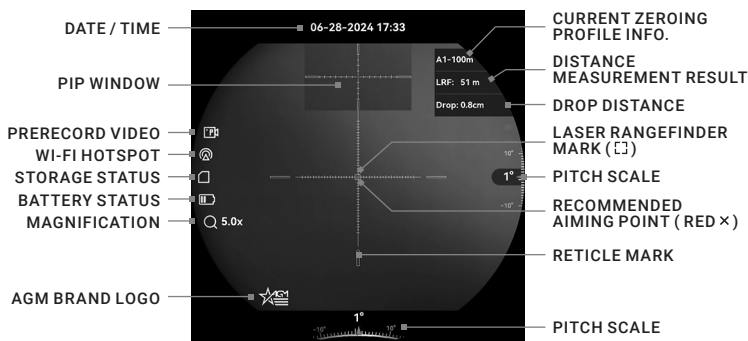

FIGURE 2-3. ON-SCREEN DISPLAY

## 2.1.9 PALETTE SETTINGS

You can select different palettes to display the same scene in different effects. In the live view mode, press the MENU button to select a mode (image palette).

TABLE 2-2. PALETTE SETTINGS

PALETTE	DESCRIPTION
WHITE HOT	The hot part is displayed in white. The higher the temperature, the lighter the color.
BLACK HOT	The hot part is displayed in black. The higher the temperature, the darker the color.
FUSION	The hot part is displayed in white. From high temperature to low temperature, the image is colored in from white, yellow, red, pink to purple.
RED HOT	The hottest part is displayed in red, the rest of the image will be flushed out in shades of gray.

## 2.1.10 DIGITAL ZOOM

Press the ZOOM button in the view mode to switch between 1x, 2x, 4x and 8x digital zoom. The image magnification value is displayed on the screen: 2.5x, 5x, 10x, 20x.

## 2.1.11 DISTANCE MEASUREMENT

The device can detect the distance between the target and the observation position with built-in laser rangefinder.

Make the laser rangefinder settings in the menu (see details in part 2.2.15). Point the square mark of the rangefinder ( ) at the target and press the LRF button to measure the distance to the target. The distance measurement result is displayed at the upper right of the image.

## 2.1.12 RECOMMENDED AIMING POINT

If you are using the ballistic calculator (see 2.2.9 for details), the recommended aiming point (red crosshair ) will be displayed on the screen and the drop distance will be indicated in the upper right corner of the interface.

## 2.1.13 PICTURE IN PICTURE

The Picture-in-Picture (PIP) mode allows you to see simultaneously both a magnified image of the central part in a PIP window and the main image. The PIP window is displayed at the up-center of the live view. In the live view you can enable or disable the PIP function by holding the ZOOM button .

The PIP window at the top of the screen displays the details of central part of the image at 2x zoom.

### NOTE:

- When the reticle is enabled, the PIP view displays a magnified area around the center of the crosshair. When the reticle is not enabled, the PIP view displays a magnified central area of the image.
- If the PIP function is activated, the image will be enlarged by the zoom factor only in the PIP window.

## 2.1.14 IMAGE CALIBRATION

Hold the LRF button  in the view mode to correct the non-uniformity of display. See part 2.2.23 for more details on the Flat Field Correction function.

## 2.1.15 VIDEO RECORDING AND IMAGE CAPTURE

### Video Recording

Hold the CAPTURE button  in the view mode and start recording. In the upper left corner, the recording time displays.

Hold the CAPTURE button  again to stop recording.

### Image Capture

Press the CAPTURE button  in the view mode, to capture the image.

### NOTE:

When captured, the image freezes for 1 second and a prompt shows on the display.

## 2.1.16 CONNECTING THE DEVICE

1. Open the cable interface cover.

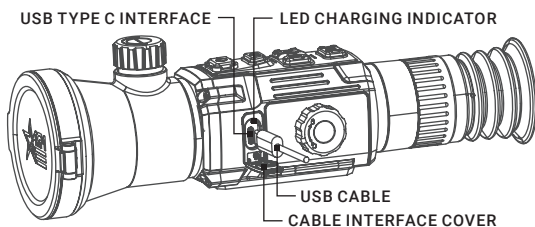

FIGURE 2-4. CABLE INTERFACE

2. Connect the device and power adapter with a USB Type-C cable to charge the battery while installed within the device. You can also supply power to the device using an external power system through the USB port. Alternatively, you may also connect the device to your computer using the included USB cable to copy/delete files. Or, your image and video content can be managed through the AGM Connect phone application.

The LED indicator near the USB port indicates the following statuses:

**Solid Red:** the device is properly charged.

**Solid Green:** the device is fully charged.

**Flashing Red & Green:** the battery is not installed and the device is powered by an external power supply / an error has occurred.

**Off:** device is not charged.

### 2.1.17 FILE EXPORT

1. Before connecting the thermal rifle scope to a computer, please make sure that the Wi-Fi function of the rifle scope is disabled.
2. Connect the thermal rifle scope to your PC with USB cable and open the detected disk.
3. The directory is named by the current date. Enter DCIM > "Date" to view the videos and snapshots.
  - Select and copy the videos to PC and play the file with the player.
  - Select and copy the snapshots to PC and view the files.
4. Disconnect the device from your PC.

#### **NOTE:**

- The device displays images when you connect it to PC. But functions such as recording, capturing and hot spot are disabled.
- When you connect the device to PC for the first time, it installs the driver automatically.

### 2.1.18 INSTALLING THE EVOLVER ON A PICATINNY/WEAVER RAIL

#### **WARNING:**

Always make sure your firearm is unloaded before you place the scope on the firearm. Reconfirm that the chamber is empty if you stop the procedure then resume later. Safe firearms handling rules should be followed at all times.

The Evolver LRF comes with a Picatinny/Weaver mount. The mount is secured to the scope with two screws. The recommended tightening torque for the fixing screws is 4-5.3 Nm (5.44-7.2 ft lb).

To install the Evolver on a Picatinny/Weaver rail, perform the following:

1. Unlock the clamping device of the scope mount by pushing down on the lever holder (A) and unlocking the lever (B).
2. Install the scope on the Picatinny/ Weaver rail so that the stop (C) slides into the transverse slot on the rail.
3. Affix the scope to the rail by locking the lever (B).
4. Verify that the clamping device is firmly holding the Evolver. If necessary, adjust the clamping device's lever-cam lock as detailed in part 2.1.19.

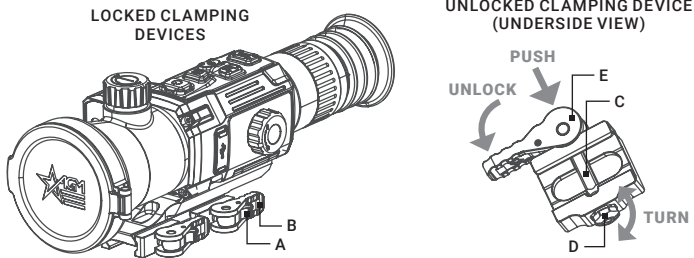

FIGURE 2-5. MOUNT

### 2.1.19 CLAMPING DEVICE ADJUSTMENT

To adjust the mount's clamping device, do the following:

1. Remove the Evolver LRF from the rail.
2. With the clamping device unlocked (as shown in Figure 2-5), push the cam (E) towards the arrow, which will cause the nut (D) to slide out of its hole.
3. To tighten/ loosen the clamping device, push down on the cam (E) and turn the nut (D) CW/ CCW respectively, in one-two increments (see note below). Much like when the cam (E) is released, backward-moving spring will cause the nut (D) to slide back into its hole.

**NOTE:**

The eight-sided nut of the mount lever-cam lock will only fit into their hole if turned in one of the discrete positions, using increments equal to  $360^{\circ}/8$ .

4. Verify that the adjusted lever-cam lock securely holds the mounting rail.

## 2.2 MAIN FUNCTIONS

### 2.2.1 MAIN MENU

In the live view mode, hold the MENU button  to display the Main Menu. In the Main Menu, you can set parameters such as Brightness, Contrast, PIP (Picture in Picture), and also select the Advanced Menu for additional settings.

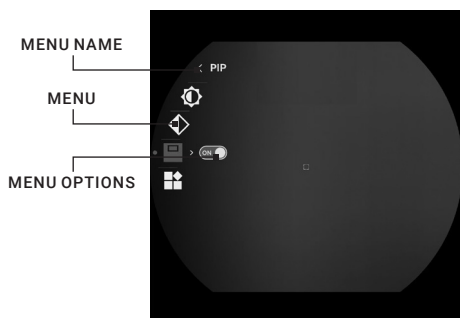













FIGURE 2-6. MAIN MENU

















Press  or  buttons to move between menu items. The active element is highlighted. Press the MENU button  to select menu item or change an option.















Hold the MENU button  to exit the menu.

TABLE 2-3. MENU FUNCTIONS







MENU ITEM	SYMBOL	OPTION	FUNCTION
<b>BRIGHTNESS</b>		10 Levels of Brightness	Adjusts the image brightness.
<b>CONTRAST</b>		10 Levels of Contrast	Adjusts the image contrast.
<b>PIP</b>		OFF / ON	Enables or disables the Picture-in-Picture (PIP) mode.
<b>ADVANCED SETTINGS</b>		<b>Advanced Settings Menu:</b>	
<b>ZEROING PROFILES</b>		5 Profiles (A/B/C/D/E)	Zeroing profile selection with user saved zeroing settings.
<b>ZEROING</b>		<b>Zeroing Menu:</b>	
Zeroing		OFF / 1 / 2 / 3 / 4 / 5	Zeroing settings selection or disable reticle.
Distance		Distance	Setting the distance to the target.





MENU ITEM	SYMBOL	OPTION	FUNCTION
Type		10 Reticle Type	Setting the reticle type.
Color		4 Reticle Colors	Setting the reticle color (black, white, red, green).
Zoom		2.5x, 5x, 10x, 20x	Setting the magnification with Digital Zoom.
Freeze Screen		OFF / ON	Image freeze.
X/Y Axis		X / Y	Switching the X and Y axes of correction. Setting the correction.
<b>BALLISTIC CALCULATION</b>		Initial Velocity / Zero Range / Altitude / Temperature / Ballistic Coefficient / Sight Height	Enables or disables the ballistic calculation. Setting up 5 profiles. Input the data to display the recommended aiming point and the drop distance.
<b>PRERECORD</b>		OFF / 7s / 10s / 15s	Setting the recording time before and after the recoil activation.
<b>IMAGE BOOST</b>		OFF / ON	Enables or disables the Image Boost for detail enhancement.
<b>TONE</b>		Cold / Warm	Switch between the Cold mode and Warm mode.
<b>SHARPNESS</b>		5 Levels of Sharpness	Adjusts the image sharpness.
<b>SCENE MODE</b>		Recognition / Jungle	Switch between the Recognition mode and Jungle mode.
<b>LASER RANGING</b>		Once / Continuous (5s, 10s, 15s, 30s, 60s)	LRF distance measurement settings.
<b>NETWORK</b>		Close / Hotspot	Enables or disables the Wi-Fi hotspot.
<b>AUTO SCREEN OFF</b>		OFF / ON	Function darkens the screen to save energy.
<b>AUDIO</b>		OFF / ON	Enable or disable audio recording.
<b>HOT TRACKING</b>		OFF / ON	Enables or disables hot spot mark (marking the spot of highest temperature).



MENU ITEM	SYMBOL	OPTION	FUNCTION
<b>FUNCTION SETTINGS</b>		<b>Function Settings Menu:</b>	
OSD		OSD / Time / Date	Enables or disables OSD, time, date.
Pitch Scale		OFF / ON	Enables or disables Pitch Scale to view the device inclination angle in the live view.
Brand Logo		OFF / ON	Enables or disables AGM logo on the screen.
Image Calib.		Auto / Semi-Auto / Manual	Selecting the Flat Field Correction (FFC) mode.
DPC		Axis: X/Y	Correction of dead pixel manually.
Burn Prevention		OFF / ON	Enables or disables the Burn Prevention function.
<b>GENERAL SETTINGS</b>		<b>General Settings Menu:</b>	
Language		23 Languages	Choice of interface language.
Time		12 / 24 hour	Time setting.
Date		Month/Day/Year	Date setting.
Unit		yard / m	Sets the distance unit.
Auto Power Off		OFF / 15 min / 30 min / 45 min	Setting the automatic shutdown time.
Restore		---	Restoring the default device settings.
Version		---	Firmware version and serial number.

## 2.2.2 BRIGHTNESS ADJUSTMENT

1. Press the MENU button  in live view interface to call the Main Menu, then select the  Brightness menu item and press the MENU button  to confirm.
2. Press  and  buttons to adjust the brightness. You can select one of ten levels of the brightness to adjust the image lighter or darker.
3. Press the MENU button  to exit brightness adjustment.





## 2.2.3 CONTRAST ADJUSTMENT

1. Press the MENU button  in live view interface to call the Main Menu, then select the  Contrast menu item and press the MENU button  to confirm.



2. Press  and  buttons to adjust the image contrast. You can select one of ten levels of the contrast.
3. Press the MENU button  to exit contrast adjustment.

#### 2.2.4 PICTURE IN PICTURE MODE

You can activate the Picture-in-Picture (PIP) function in the Main Menu.









1. Hold the MENU button  in live view interface to call the Main Menu and then select the  PIP menu item.
2. Press the MENU button  to enable or disable PIP mode. The PIP window show in the upper part of screen.
3. Hold the MENU button  to exit PIP setting.

#### 2.2.5 ADVANCED SETTINGS MENU

Hold the MENU button  in the view interface to call the Main Menu. Select the  Advanced Settings menu and press the MENU button  to confirm. The Advanced Settings menu contains all the necessary parameters to fully configure the device.

#### 2.2.6 ZEROING PROFILES

The user can customize and save five profiles with different reticle settings. In each profile, you can configure up to five types of reticle, firing distances and reticle corrections.

1. Enter the  Advanced Settings menu.
2. Press  or  button to select  Zeroing Profiles menu item and press the MENU button  to confirm.
3. Press  or  button to switch the zeroing profile.
4. Press the MENU button  to exit Zeroing Profile setting.

The right top of the image displays the reticle information. For example, A1-100m means you are using the Zeroing No. 1 in the Profile A, and the set range is 100 m.













#### NOTE:







There are 5 zeroing profiles in total, and you can configure 5 reticles, zeroing distances and corrections in each zeroing profile.

#### 2.2.7 ZEROING

You can select a reticle in the current zeroing profile, and set parameters such as reticle type, color, and boresight correction (coordinates) for the reticle.







Select a zeroing profile initially (refer to 2.2.6).

1. Enter the  Advanced Settings menu.
2. Press  or  button to select  Zeroing menu item and press the MENU button  to enter the zeroing setting interface.
3. Set zeroing number (from 1 to 5).
  - 1) Press  or  to select  Zeroing and press the MENU button  to confirm.
  - 2) Press  or  button to select OFF (reticle is disabled) or zeroing number you want to correct and press the MENU button  to confirm.

4. Set reticle type (for parameters of all built-in reticles, see part 5.2).
  - 1) In the zeroing setting interface press  or  button to select  Type submenu and press the MENU button  to confirm.
  - 2) Press  or  button to select a reticle type and press the MENU button  to confirm.

**NOTE:**

The scale intervals of the Reticle 4 and Reticle 7 change synchronously under the current digital zoom.

5. Set reticle color.
  - 1) In the zeroing setting interface press  or  button to select  Color submenu and press the MENU button  to confirm.
  - 2) Press  or  button to select black, white, red or green color of reticle and press the MENU button  to confirm.

**NOTE:**

In Black Hot mode and White Hot mode, if you set the reticle color as white or black, the reticle colors can be automatically inverted depends on thermal image around the reticle.













6. (Optional) Repeat 3 to 5 to set type and color for other reticles in this profile.
7. Hold the MENU button  to save and exit.

## 2.2.8 BORESIGHTING

Like any daytime rifle scope or red dot, sighting in is both similar, and simplified. The Evolver LRF comes with a one-shot zeroing system, which makes initial sighting in quick and painless.

Set the target to the selected zeroing distance. We recommend 50-100 yards initially. Select a zeroing profile (refer to 2.2.6). You can use different zeroing profiles if you want to use the optic on a different rifles.

Align the reticle with the center of the target and shoot. If the point of impact does not coincide with the aiming point, correct the reticle.

1. Enter the  Advanced Settings menu.
2. Press  or  button to select  Zeroing menu item and press the MENU button  to enter the zeroing setting interface.
3. Press  or  button to select  Zeroing and press the MENU button  to confirm. Press  or  button to select zeroing number you want to correct and press the MENU button  to confirm.

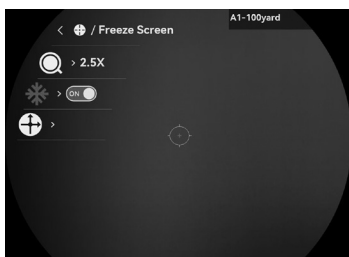















FIGURE 2-7. BORESIGHTING





4. Set the distance to the target:

- 1) In the zeroing setting interface press  or  button to select  Distance and press the MENU button  to confirm.
- 2) Press the MENU button  to select the digit you want to change (color of selected digit will change to the red).
- 3) Press  or  button to change the number and press the MENU button  to confirm.

5. (Optional) Press  or  button to select  Zoom option, and press  or  button to enlarge the image until the target positions is clear enough. Press the MENU button  to confirm.

**NOTE:**

We'd suggest zeroing in at 1x, or your true optical base magnification, or 2x zoom (double your optical magnification) as these options are less pixelated and should provide for easier adjustments.



6. (Optional) Press  or  button to select  Freeze Screen option, and press the MENU button  to enable the Freeze Screen function.

**NOTE:**

When enabling the Freeze Screen function, you can adjust the position of the cursor on a frozen image. This feature helps prevent image flutter and eliminates the need to hold the rifle scope steady in order to make your windage and elevation adjustments on screen.

7. Select  X/Y Axis and press the MENU button  to confirm.

Two crosshairs are displayed on the screen. The big one is reticle crosshair, and the small one is reference crosshair. Reference crosshair will appear in the centre of the display. Initially, the centers of both crosshairs are aligned. Zero the scope by moving the reticle on the screen:

- 1) Aim the reticle at the center of target.
- 2) Press the MENU button  to select X or Y axis.
- 3) Press  or  button to move reticle left and right (if X axis is selected) or to move reticle up and down (if Y axis is selected).

Holding the reference small crosshair at the aiming point (center of the target) and move the reticle until it is aligned with the point of impact. The coordinates show the current position of the reticle. It also displays the distance by which the point of impact will move, taking into account the set distance to the target.

8. Hold the MENU button  to save reticle position and exit.

9. (Optional) Repeat 3 to 8 to set the position for other reticles in this profile. You can place up to five zeroes at different distances within the same profile (useful for certain calibers with highly fluctuating trajectories between 50 and 250 yards/meters).

TABLE 2-4. BORESIGHT CORRECTION

ADJUSTMENT VALUE	RETICLE OFFSET	BORESIGHT INCREMENT
1 click	1 pixel	0.18 mil / 0.63 MOA / 1.8 cm at 100 m distance / 0.65 in at 100 yd distance











10. Hold the MENU button  to exit Zeroing menu. The window "Save the parameters?" will appear.
  - OK: Save the settings and exit.
  - CANCEL: Exit without saving the settings.

## 2.2.9 BALLISTIC CALCULATION

The ballistic calculation helps you have a better experience in various conditions. Multiple parameters are required in calculation to ensure precision and flexibility of use.

### NOTE:

Make sure the reticle is enabled and you have finished zeroing.

1. Enter the  Advanced Settings menu.
2. Press  or  button to select  Ballistic Calculation. Press the MENU button  to enter the setting interface.
3. Select Ballistic Calculation and press the MENU button  to on/off this function.
4. Press  or  button to select Ballistic Profile and press the MENU button  to switch the profile (from 1 to 5). You can configure and save different settings for each of the 5 profiles.
5. Press  or  button to select the following parameters, and press the MENU button to input the data.

**Initial Velocity:** Input the muzzle velocity of your projectile.

### NOTE:

Velocity varies depending on different conditions, barrel length, etc. Muzzle velocity can be obtained by using an accurate ballistic chronograph and/or by following ammo manufacturer specifications.







**Zero Range:** Set the distance you have zeroed the device at.

**Altitude:** Set current local altitude.

**Temperature:** Set the ambient temperature.

**Ballistic Coefficient (B.C.):** The measure of its ability to overcome air resistance.

**Sight Height:** The distance between the bore and the center of the lens.









5. Press the MENU button  to switch digit, and press  or  to change the number.
6. Hold the MENU button  to save and exit.
7. Aim the LRF mark at the target and press LRF button  to measure the distance. The screen will display the recommended aiming point (red crosshair ) and the drop distance in the upper right corner of the interface.
8. (Optional) To adjust distance, repeat the step 7.

### NOTE:

- 5 ballistic profiles can be saved.
- The more parameters you specify, the more accurate the recommended aiming point will be.
- The drop distance is related to the input parameters. Please refer to the actual situation.









## 2.2.10 PRERECORD VIDEO

After enabling the Shot Activated Recording (SAR) function, the device will automatically start recording 7, 10, or 15 seconds before and after the recoil-activation.

1. Enter the  **Advanced Settings** menu.
2. Press  or  to select  **Prerecord** and press the MENU button  to open the options.
3. Press  or  button to select OFF (disabled SAR) or 7s, 10s, 15s recording time and press the MENU button  to confirm the selection and exit.









## 2.2.11 IMAGE BOOST

Activate the Image Boost function for image detail enhancement.

1. Enter the  **Advanced Settings** menu.
2. Press  or  to select the  **Image Boost** menu item and press the MENU button  to enable or disable Image Boost.
3. Press  or  to select to select other menu item or hold the MENU button  to exit a menu.









## 2.2.12 IMAGE TONE SETTING

This function allows you to change the tone of thermal image to warm or cold.

1. Enter the  **Advanced Settings** menu.
2. Press  or  button to select  **Tone** menu item and press the MENU button  to confirm.
3. Press  or  button to select **Warm** or **Cold** tone.
4. Press the MENU button  to exit.







## 2.2.13 SHARPNESS SETTING

This function allows you to adjust the sharpness of the thermal image.

1. Enter the  **Advanced Settings** menu.
2. Press  or  button to select  **Sharpness** menu item and press the MENU button  to confirm.
3. Press  or  button to adjust the image sharpness.
4. Press the MENU button  to exit.

## 2.2.14 SCENE MODE

You can select proper Scene Mode according to environment temperature to improve the display effect.

1. Enter the  **Advanced Settings** menu.
2. Press  or  button to select  **Scene Mode** menu item and press the MENU button  to confirm.
3. Press  or  button to switch scene mode:









**Recognition mode:** improves an image so that the object edge is more distinct.

**Jungle mode:** is more suitable for hunting environment because of the highlight function of small objects.

4. Press the MENU button  to exit.

### 2.2.15 SET LASER RANGING

The device can detect the distance between the target and the observation position with built-in laser rangefinder.

1. Enter the  **Advanced Settings** menu.
2. Press  or  button to select  **Laser Ranging** menu item and press the MENU button  to open the options.
3. Press  or  button to select the laser ranging mode between **Once** and **Continuous (5s)**, **Continuous (10s)**, **Continuous (15s)**, **Continuous (30s)**, **Continuous (60s)**. Press the MENU button  to set selected mode.
4. Press the MENU button  to confirm and exit.







When the **Once Mode** is selected, point the square mark of the rangefinder at the target and press the LRF button  to measure the distance to the target.

You can scan the surroundings under **Continuous Mode**. Continuous distance scanning will occur for a set time of 5, 10, 15, 30 or 60 seconds after pressing the LRF button .

The distance measurement result is displayed at the upper right of the image.

### 2.2.16 NETWORK CONFIGURATION

Connect your phone to the Wi-Fi hotspot of the rifle scope, you can configure the parameters and realize functions of the device.

1. Enter the  **Advanced Settings** menu.
2. Press  or  button to select  **Network** menu item and press the MENU button  to enable or disable Wi-Fi hotspot.
3. Hold the MENU button  to exit.









Open the AGM Connect APP and connect your phone with the device (refer to Section 2.3). You can view the interface of rifle scope on your phone.

#### **NOTE:**

When the power is less than 15%, the Wi-Fi hotspot function will be turned off automatically.

### 2.2.17 AUTO SCREEN OFF

Auto screen off function darkens the screen to save energy and increase battery time. However, the device stays on and you can view the live view on AGM Connect app when connecting the device to the app.

1. Enter the  **Advanced Settings** menu.
2. Press  or  button to select  **Auto Screen Off** menu item. Press the MENU button  to enable or disable Auto Screen Off function.
3. Press  or  to select other menu item or hold the MENU button  to exit.

You can use one of the following methods to enter the standby mode when the display is turned on:

- Tilt the device downwards more than 70°.
- Rotate the device horizontally more than 75°.
- Keep the device still and do not move it for 5 minutes.











You can do one of the following methods to wake up the device when the display is turned off:

- Tilt the device downwards from 0° to 60° or upwards .
- Rotate the device horizontally from 0° to 75°.
- Press  to wake up the device.









### 2.2.18 AUDIO RECORDING SETTING

The Audio function allows you to record sound along with video. If there is too much noise when recording, this function can be disabled.

1. Enter the  **Advanced Settings** menu.
2. Press  or  button to select  **Audio** menu item, and press the MENU button  to enable or disable audio recording.
3. Press  or  to select other menu item or hold the MENU button  to exit.

### 2.2.19 HOT TRACKING













The device can detect the highest temperature spot in the scene and mark it on display.

1. Enter the  **Advanced Settings** menu.
2. Press  or  button to select  **Hot Tracking** menu item and press the MENU button  to enable/disable hot spot mark (marking the spot of highest temperature).
3. Press  or  to select other menu item or hold the MENU button  to exit.

When the hot spot mark is enabled, the green cross mark  displays in the spot of the highest temperature. When the scene changes, the green mark moves.





### 2.2.20 ON-SCREEN DISPLAY (OSD)

You can choose which OSD information to display in the live view user interface. Options include, wi-fi hotspot activation, current magnification, memory storage status, battery indicator status, time and date. These will appear at the top of the display interface when activated.

1. Enter the  **Advanced Settings** menu.
2. Press  or  button to select  **Function Settings** menu and press the MENU button  to confirm.
3. Press  or  button to select  **OSD** OSD submenu and press the MENU button  to enter.
4. Press  or  button to select the **OSD, Time or Date**. Press the MENU button  to display or hide the necessary information.
5. Hold the MENU button  to exit.

### 2.2.21 PITCH SCALE

You can enable pitch scale to view the device inclination angle in the live view.

1. Enter the  **Advanced Settings** menu.
2. Press  or  button to select  **Function Settings** menu and press the MENU button  to confirm.

3. Press or button to select Pitch Scale and press the MENU button to turn the on-screen pitch scale on or off.
4. Press or to select other menu item or hold the MENU button to exit.

### 2.2.22 BRAND LOGO

You can display the AGM logo in the lower left corner of the screen.

1. Enter the Advanced Settings menu.
2. Press or button to select Function Settings menu and press the MENU button to confirm.
3. Press or button to select Brand Logo menu item. Press the MENU button to enable/disable logo.
4. Press or button to select other item or hold the MENU button to exit.

### 2.2.23 IMAGE CALIBRATION

The image calibration function performs what is known as the Flat Field Correction (FFC). This is required of all thermal devices. This can correct for non-uniformity of the display. During correction an internal shutter will be lowered in front of the thermal detector. A “click” sound will often be heard, and the image is momentarily interrupted for a split second. After this quick process the detector will be re-calibrated, and the image becomes more accurate. AGM recommends automatic when scanning for game or targets. However, we recommend going into the menu and changing to Manual correction mode when getting close making your shot. This will prevent any unwanted auto-correction occurring when tracking live game. This will help shooters in making ethical shot placements at all times.

1. Enter the Advanced Settings menu.
2. Press or button to select Function Settings menu and press the MENU button to confirm.
3. Press or button to select Image Calib. submenu and press the MENU button to enter.
4. Press or button to switch the FFC mode.

**Auto:** The rifle scope performs FFC automatically when switching on or rebooting the camera.

**Semi-Auto:** Hold the LRF button in live view to correct the non-uniformity of display.















**Manual:** Cover the lens cap, then hold the LRF button in live view to correct the non-uniformity of display.

5. Hold the MENU button to exit.

### 2.2.24 DEFECTIVE PIXELS CORRECTION













The Defective Pixel Correction (DPC) can help users repair the occasional deactivated pixel within the display. This is fairly common in thermal optics, which is why so many of these optics come equipped with a DPC feature. 1-3 dead pixels are usually easily repaired by the user. Anything over 3 that cannot be repaired, will open the unit up to an approved warranty repair by AGM at their facility.

Before you start switch the palette to White Hot mode.

1. Enter the  **Advanced Settings** menu.
2. Press  or  button to select  **Function Settings** menu and press the MENU button  to confirm.
3. Press  or  button to select  **DPC** submenu and press the MENU button  to enter.
4. Press the MENU button  to select the X or Y axis.
5. Press  or  button to set the coordinates until the cursor reaches the dead pixel. The screen will display a magnified area around the selected pixel.
6. Press the MENU button  twice to correct the dead pixel.
7. (Optional) Repeat 4 to 6 to correct the position for other dead pixels.
8. Hold the MENU button  to exit.













### 2.2.25 BURN PREVENTION

This function can prevent damage to the thermal sensor from the sun or other high temperature bright light sources. When enabling this function, the shield will close until the environment turns to normal. This feature may be useful to help protect sensitive displays during extreme summer temperatures. AGM recommends all units be stored in room temperature whenever possible, as long periods of storage in extreme heat (such as inside a vehicle) may lead to issues with the display materials.









1. Enter the  **Advanced Settings** menu.
2. Press  or  button to select  **Function Settings** menu and press the MENU button  to confirm.
3. Press  or  button to select  **Burn Prevention** submenu and press the MENU button  to enable or disable the Burn Prevention function.
4. Press  or  button to select other item or hold the MENU button  to exit.





### 2.2.26 LANGUAGE SETTING

You can select different languages of user interface.













1. Enter the  **Advanced Settings** menu.
2. Press  or  button to select  **General Settings** and press the MENU button  to confirm.
3. Press  or  button to select  **Language** submenu and press the MENU button  to enter.
4. Press  or  button to select the language as required and press the MENU button  to confirm.
5. Hold the MENU button  to exit.

### 2.2.27 TIME SETTING

1. Enter the  **Advanced Settings** menu.
2. Press  or  button to select  **General Settings** and press the MENU button  to confirm.
3. Press  or  button to select  **Time** submenu and press the MENU button  to enter the configuration interface.













4. Press the MENU button  to select the hour, minute, second to be synchronized and press  or  button to change the number.
5. Hold the MENU button  to exit.

### 2.2.28 DATE SETTING

1. Enter the  Advanced Settings menu.
2. Press  or  button to select  General Settings and press the MENU button  to confirm.
3. Press  or  button to select  Date submenu and press the MENU button  to enter the configuration interface.
4. Press the MENU button  to select the month, day or year to be synchronized and press  or  button to change the number.
5. Hold the MENU button  to exit.













### 2.2.29 UNIT SETTING

You can set the unit (yards or meters) of measurement for distance.

1. Enter the  Advanced Settings menu.
2. Press  or  button to select  General Settings and press the MENU button  to confirm.
3. Press  or  button to select  Unit submenu and press the MENU button  to enter the configuration interface.
4. Press  or  button to select Yard or Meter.
5. Hold the MENU button  to exit a menu.









### 2.2.30 AUTO POWER OFF

You can set the time for the automatic shutdown of the device as required.

1. Enter the  Advanced Settings menu.
2. Press  or  button to select  General Settings and press the MENU button  to confirm.
3. Press  or  button to select  Auto Power Off submenu and press the MENU button  to enter the configuration interface.
4. Press  or  button to select OFF, 15 min, 30 min or 45 min.
5. Press the MENU button  to exit.









### 2.2.31 RESTORE DEVICE

You can reset the settings of device.

1. Enter the  Advanced Settings menu.
2. Press  or  button to select  General Settings and press the MENU button  to confirm.
3. Press  or  button to select  Restore and press the MENU button . The window "Initialize?" will appear.
  - OK: Restore the device to defaults.
  - CANCEL: Exit without changing the settings.

## 2.2.32 VERSION

You can view the device information such as firmware version and serial number.

1. Enter the  **Advanced Settings** menu.
2. Press  or  button to select  **General Settings** and press the MENU button  to confirm.
3. Press  or  button to select  **Version** item and press the MENU button  to confirm. The firmware version and serial number will be displayed.

## 2.3 CLIENT SOFTWARE INTRODUCTION

Search the AGM Connect software in App Store (iOS System) or Google Play™ (Android System) and install the application on your mobile phone. Turn on the WiFi hotspot on the thermal device and then connect your phone to the hotspot.



- Hotspot Name: Wlan-<Serial No.>

- Hotspot Password: Last 9 digits of Serial Number of your thermal scope.

### NOTE:

The device password is set by user at first activation. If the password was lost or forgotten, it can be reset. To reset a password perform the following steps:

1. When the thermal device is turned on, hold the MENU button  to activate the Main menu.

2. Select  **Restore** item in the General Settings menu and press the MENU button  to restore all parameters to default settings.

1. Run the app and connect the phone or tablet with the device.

2. If the device is inactivated, set the password and activate it. If the device is activated, enter the password to add it to the app.

3. When the device is added, the live view can be seen. You can view the interface of the device on the software. User can change such image parameters as brightness, contrast, zoom, palettes directly via phone or tablet as well as record video on phone/tablet memory.

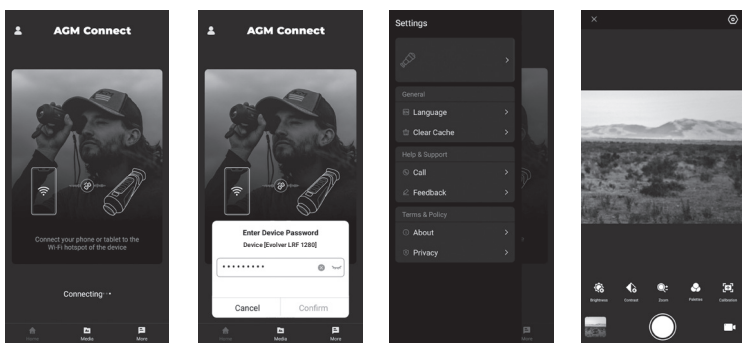

FIGURE 2-8. AGM CONNECT APP

# 3 MAINTENANCE

## 3.1 MAINTENANCE

### 3.1.1 CLEANING PROCEDURES

1. Gently brush off any dirt from the body of the device using a clean, soft cloth.
2. Moisten the cloth with fresh water and gently wipe down the external surfaces (except lenses).
3. Dry any wet surfaces (except lenses) using another dry, clean, soft cloth.
4. Using a lens brush, carefully remove all loose dirt from the lenses.
5. Use a high quality lens wipe to remove dirt or smudges from the lens and display window. Do not use abrasives or solvents to clean the housing, lens, or display window. Clean the glass surfaces using circular movements, starting from the center of the lens and moving out towards the edge.
6. Clean the accessories with a soft brush (or cloth) dampened with soap and water.

### 3.1.2 PREPARING FOR EXTENDED STORAGE

#### **CAUTION:**

Thoroughly dry each item before placing them into the storage case.

To prepare the rifle scope for extended storage:

1. Clean the rifle scope with a damp cloth to remove any dust, dirt or debris.
2. Remove the batteries.
3. Close the lens cap, and place items into their soft carrying case.

### 3.1.3 UPDATING THE DEVICE FIRMWARE

#### **WARNING:**

Please make sure the device is connected to the computer during the entire update process. Otherwise, it may cause unnecessary upgrade failure, firmware damage, etc.

1. Visit [www.agmglobalvision.com/firmware](http://www.agmglobalvision.com/firmware) website. Select your product, download the firmware update package to your PC and unzip it. Follow the detailed instructions on the website.
2. Connect the device to your PC with USB cable.
3. Turn on the device. Make sure the Wi-Fi hotspot function is disabled.
4. Open the detected disk (USB drive) in file manager program. Copy the unzipped `digicap.dav` file and paste it to the root directory of the device.

5. Turn off the device completely, then power it back on. After awhile, the firmware update process will start automatically. During the update, the screen will display the inscription “Upgrading...”. The update process will be completed when the inscription “Upgrading...” goes out.

6. Turn off the device and disconnect it from your PC.

You can also enjoy automatic update function in AGM Connect App (see section 2.3 for details).

1. Start the AGM Connect App and tap the Settings icon in the left top corner.

2. Tap your device in the device list. The information about your device will be shown.

3. Tap **Checking for Upgrade** to detect and download the latest FW version.

## 3.2 TROUBLESHOOTING

Table 3-1 lists the most common malfunctions that may occur with your equipment. This table does not list all the malfunctions that may occur with your device. If the equipment malfunction is not corrected by the suggested actions, or a problem occurs that is not listed in this table, please contact AGM Global Vision’s Customer Support center or your retailer.

TABLE 3-1. TROUBLESHOOTING

MALFUNCTION	CORRECTIVE ACTION
The scope fails to activate.	<ol style="list-style-type: none"> <li>1. Battery are missing or improperly installed. Insert batteries or install correctly.</li> <li>2. Battery are dead. Replace or charge the battery.</li> <li>3. Battery, surfaces or contacts are dirty or corroded. Clean the contacts.</li> </ol>
The scope shut off sometimes after shot.	<ol style="list-style-type: none"> <li>1. Low battery level. Check the remaining capacity of the battery, which may be low on power to maintain performance. Replace or charge the battery.</li> </ol>
The image is not clear.	Perform the sight adjustment referring to section 2.1.
Wi-Fi is not found.	Examine whether the Wi-Fi function is turned on. If not, turn on the Wi-Fi hotspot in the menu.
Capturing or recording fails.	<ol style="list-style-type: none"> <li>1. The device is connected to your PC and has disabled the capturing and recording. Disconnect the device.</li> <li>2. The storage space is full. Delete old files.</li> <li>3. The device is in a low-battery condition. Replace the battery.</li> </ol>
The PC cannot identify the scope.	<ol style="list-style-type: none"> <li>1. The device is connected to your PC with standard USB cable. If you use other USB cables, make sure the cable length is no longer than 1 m.</li> <li>2. The Wi-Fi function is turned on. If so, turn off the Wi-Fi hotspot in the menu.</li> </ol>

## 4 WARRANTY INFORMATION

### 4.1 WARRANTY INFORMATION AND REGISTRATION

The below description of AGM Global Vision warranty terms and conditions refer specifically to AGM branded products purchased within the United States. Customers purchasing AGM products outside the United States can obtain specific information about their product's warranty term on the [www.agmglobalvision.eu](http://www.agmglobalvision.eu) website.

#### 4.1.1 WARRANTY INFORMATION

This product is guaranteed to be free from manufacturing defects in material and workmanship under normal use for a period of five (5) years from the date of purchase. In the event that a defect covered by the warranty below occurs during the applicable period stated above, AGM Global Vision, at its discretion, will either repair or replace the product; such action on the part of AGM Global Vision shall be the full extent of AGM Global Vision's liability, and the Customer's sole and exclusive reparation. This warranty does not cover a product if it has been (a) used in ways other than its normal and customary manner; (b) subjected to misuse; (c) subjected to alterations, modifications or repairs by the Customer or by any party other than AGM Global Vision without prior written consent of AGM Global Vision; (d) is the result of a special order or categorized as "close-out" merchandise or merchandise sold "as-is" by either AGM Global Vision or the AGM Global Vision dealer; or (e) merchandise that has been discontinued by the manufacturer and either parts or replacement units are not available due to reasons beyond the control of AGM Global Vision. AGM Global Vision shall not be responsible for any defects or damage that in AGM Global Vision's view are a result from the mishandling, abuse, misuse, improper storage or improper operation of the device, including use in conjunction with equipment that is electrically or mechanically incompatible with, or of inferior quality to, the product, as well as failure to maintain the environmental conditions specified by the manufacturer. This warranty is extended only to the original purchaser. Any breach of this warranty shall be enforced unless the customer notifies AGM Global Vision at the address noted below within the applicable warranty period.

The customer understands and agrees that except for the foregoing warranty, no other warranties written or oral, statutory, expressed or implied, including any implied warranty of merchantability or fitness for a particular purpose, shall apply to the product. All such implied warranties are hereby and expressly disclaimed.

#### 4.1.2 LIMITATION OF LIABILITY

AGM Global Vision will not be liable for any claims, actions, suits, proceedings, costs, expenses, damages, or liabilities arising out of the use of this product. Operation and use of the product are the sole responsibility of the Customer. AGM Global Vision's sole undertaking is limited to providing the products and services outlined herein in accordance with the terms and conditions of



this Agreement. The provision of products sold and services performed by AGM Global Vision to the Customer shall not be interpreted, construed, or regarded, either expressly or implied, as being for the benefit of or creating any obligation toward any third party of legal entity outside AGM Global Vision and the Customer; AGM Global Vision's obligations under this Agreement extend solely to the Customer. AGM Global Vision's liability hereunder for damages, regardless of the form or action, shall not exceed the fees or other charges paid to AGM Global Vision by the customer or customer's dealer. AGM Global Vision shall not, in any event, be liable for special, indirect, incidental, or consequential damages, including, but not limited to, lost income, lost revenue, or lost profit, whether such damages were foreseeable or not at the time of purchase, and whether or not such damages arise out of a breach of warranty, a breach of agreement, negligence, strict liability, or any other theory of liability.

#### **4.1.3 PRODUCT REGISTRATION**

In order to validate the warranty on your product, the customer must complete and submit AGM Global Vision PRODUCT REGISTRATION FORM on our website ([www.agmglobalvision.com/customer-support](http://www.agmglobalvision.com/customer-support)).

#### **4.1.4 OBTAINING WARRANTY SERVICE**

To obtain warranty service on your unit, the End-user (Customer) must notify the AGM Global Vision service department via e-mail. Send any requests to [support@agmglobalvision.com](mailto:support@agmglobalvision.com) to receive a Return Merchandise Authorization number (RMA). When returning any device, please take the product to your retailer, or send the product, postage paid and with a copy of your sales receipt, to AGM Global Vision's service center at the address listed above. All merchandise must be fully insured with the correct postage; AGM Global Vision will not be responsible for improper postage or merchandise that becomes lost or damaged during shipment. When sending product back, please clearly write the RMA# on the outside of the shipping box. Please include a letter that indicates your RMA#, the Customer's Name, a Return Address, reason for the return, contact information (valid telephone numbers and/or an e-mail address), and proof of purchase that will help us to establish the valid start date of the warranty. Product merchandise returns that do not have an RMA# listed may be refused, or a significant delay in processing may occur. Estimated Warranty service time is 10-20 business days. The End-user/Customer is responsible for postage to AGM Global Vision for warranty service. AGM Global Vision will cover return postage/shipping after warranty repair to the End-user/Customer only if the product is covered by the aforementioned warranty. AGM Global Vision will return the product after warranty service by domestic UPS Ground service and/or domestic mail. Should any other requested, required, or international shipping methods be necessary, the postage/shipping fee will be the responsibility of the End-user/Customer.

For service, repair or replacement, please contact:

#### **AGM Global Vision, LLC**

173 West Main Street

PO Box 962

Springerville, AZ 85938

Tel. 928.333.4300

[support@agmglobalvision.com](mailto:support@agmglobalvision.com)

[www.agmglobalvision.com](http://www.agmglobalvision.com)

# 5 SPECIFICATIONS

## 5.1 SPECIFICATIONS

EVOLVER LRF 1280	
Detector Type	12 $\mu$ m VOx Uncooled Focal Plane Array
Resolution	1280 × 1024
Frame Rate	25 fps
NETD	Less than 18 mK (@25°C), F#=1.0
Lens System	65mm, F 1.0
Field of View (H×V)	13.5° × 10.8°
Magnification	2.5× – 20×
Digital Zoom	1×, 2×, 4×, 8×
Detection Range (6' object)	3,250 m
Eye Relief	45 mm
Exit Pupil	6 mm
Diopter Adjustment	-5 to +5 dpt
Monitor	2560*2560, 1.03 inch, OLED
FFC (Flat Field Correction)	Auto, Semi-Auto, Manual,
Palettes	Black Hot, White Hot, Red Hot, Fusion
Reticle	10 types, 4 colors, on/off
Boresight Adjustment	Digital Controlled
Laser Range Finder	Up to 1000 m, $\pm$ 4 m accuracy
Minimum Measuring Distance	10 m
Laser Wavelength	905 nm
Laser Safety Class	Class 1
Ballistic Calculation	Yes
Highest Temperature Spot Tracking	Yes
Defective Pixel Correction	Yes
WiFi Hotspot	Yes

EVOLVER LRF 1280	
Standby Mode	Yes
Picture-in-Picture Mode	Yes
Burn Prevention	Yes
Built-in Storage	64 GB EMMC
Video with Audio Recording	Yes (1280×1280)
Image Capture	Yes (1280×1280)
Shot Activated Recording (SAR)	Yes
Battery Type	NA-4400 Replacable and Rechargeable Li-ion Battery (4,400 mAh)
Battery Life (WiFi and LRF off)	4 h (25 °C)
External Power	5 VDC/2 A, USB Type-C
Working Temperature	-30°C to 55°C (-22°F to 131°F)
Protection Level	IP67
Max/ Recoil	1,000 g / 0.4 ms
Dimensions (w/o mount)	270 × 115 × 88 mm (10.6 × 4.5 × 3.4 in)
Weight (w/o mount and battery)	0.79 kg (1.75 lb)

*All data subject to change without notice.*

## 5.2 RETICLE PARAMETERS

IMAGE	ITEM	MOA	CM @100M	IN @100YD
<b>RETICLE 1</b>				
	A	178.2	518.4	186.6
	B	179.5	522.1	187.9
	C	6.3	18.3	6.6
	D	36.7	105.2	38.4
	E	10.8	31.4	11.3
<b>RETICLE 2</b>				
	A	215.5	627.1	225.6
	B	201.6	586.6	211.1
	C	4.4	12.9	4.6
<b>RETICLE 3</b>				
	A	215.5	627.1	225.6
	B	202.2	588.4	211.7
	C	4.4	12.9	4.6

IMAGE	ITEM	MOA	CM @100 M	IN @100 YD
<b>RETICLE 4</b>				
	A	168.7	490.8	176.6
	B	152.9	444.7	160.1
	C	40.0	116.3	41.9
	D	7.0	20.3	7.3
	E	48.2	140.3	50.5
	F	4.4	12.9	4.6
	G	7.0	20.3	7.3
	H	7.0	20.3	7.3
	I	4.4	12.9	4.6
	J	8.3	24.0	8.7
	K	5.7	16.5	6.0
<b>RETICLE 5</b>				
	A	5.7	16.6	6.0
	B	6.4	18.5	6.7
	C	1.9	5.5	2.0
	D	1.3	3.7	1.4
<b>RETICLE 6</b>				
	A	12.1	35.1	12.7
	B	1.9	5.5	2.0

IMAGE	ITEM	MOA	CM @100M	IN @100YD
<b>RETICLE 7</b>				
	A	215.5	627.1	225.6
	B	175.0	509.2	183.2
	C	41.3	120.0	43.2
	D	5.7	16.6	6.0
	E	4.4	12.9	4.6
	F	5.7	16.6	6.0
	G	8.3	24.0	8.7
	H	3.2	9.2	3.4
	I	5.1	14.8	5.3
	J	8.3	24.0	8.7
<b>RETICLE 8</b>				
	A	193.4	562.6	202.5
	B	46.3	134.8	48.5
	C	4.4	12.9	4.6
<b>RETICLE 9</b>				
	A	5.1	14.8	5.3
	B	46.3	134.8	48.5
	C	4.4	12.9	4.6
<b>RETICLE 10</b>				
	A	8.3	24.0	8.7

All data subject to change without notice.

**NOTE:**

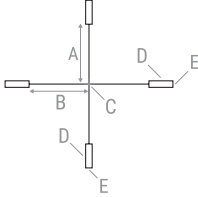
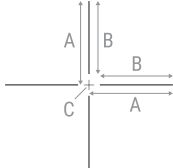
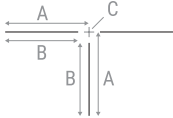
The scale intervals of the Reticle 4 and Reticle 7 change synchronously under the current digital zoom.





## **AGM Global Vision, LLC**

### **MAIN OFFICE**

173 West Main Street

PO Box 962

Springerville, AZ 85938

USA

Tel. +1.928.333.4300

[info@agmglobalvision.com](mailto:info@agmglobalvision.com)

[www.agmglobalvision.com](http://www.agmglobalvision.com)

### **EUROPEAN OFFICE**

#6 Andrey Lyapchev Blvd

Sofia, P.C. 1756

Bulgaria

Tel. +35.988.560.0326

[info@agmglobalvision.eu](mailto:info@agmglobalvision.eu)

[www.agmglobalvision.eu](http://www.agmglobalvision.eu)

### **DOWNLOAD AGM CONNECT APP:**



Google Play Store



Apple App Store

[AGMglobalvision.com](http://AGMglobalvision.com)