

TAIPAN V²

THERMAL IMAGING MONOCULAR

USER MANUAL

© 2024 AGM Global Vision, LLC. All rights reserved.

This documentation is subject to change without notice.

No parts of this manual, in whole or in part, may be copied, photocopied, translated, or transmitted by any electronic medium or in machine-readable form without the prior written permission of AGM Global Vision, LLC.

Approved for public release, distribution unlimited.

If you have questions that are not covered in this manual, or need service, contact AGM Global Vision customer support for additional information prior to returning a product.

AGM Global Vision, LLC

173 West Main Street

PO Box 962

Springerville, AZ 85938

Tel. 928.333.4300

support@agmglobalvision.com

www.agmglobalvision.com

EXPORT INFORMATION

Buyer acknowledges that all products supplied by AGM Global Vision, LLC are subject to U.S. export control laws, including, but not limited to, the Export Administration Regulations, the International Traffic in Arms Regulations, the International Economic Emergency Powers Act, and various U.S. embargoes and sanctions. AGM Global Vision products may not be exported, re-exported, or transferred contrary to U.S. export control laws. In particular, AGM Global Vision products may not be exported, re-exported, or transferred to prohibited countries, individuals, organizations, or entities, including but not limited to those individuals and entities listed on the List of Specially Designated Nationals and Blocked Persons administered or maintained by the U.S. Office of Foreign Assets Control ("OFAC"), the various lists maintained by the Bureau of Industry and Security of the Department of Commerce, and the U.S. State Department and Buyer represents and warrants that neither Buyer nor any of its officers, directors, or employees are on such lists. Distribution or resale by Buyer to such countries, individuals, organizations, or entities is expressly prohibited. Buyer has and will maintain a positive process to ensure compliance with this Section.

FCC INFORMATION

Please note that changes or modification not expressly approved by the party responsible for compliance could void the user's authority to operate the equipment.

This equipment complies with FCC/IC RSS-102 radiation exposure limits set forth for an uncontrolled environment.



FCC compliance: This product has been tested and found to comply with the limits for a Class B digital device, pursuant to Part 15 of the FCC Rules. These limits are designed to provide reasonable

protection against harmful interference in a residential installation. This product generates, uses, and can radiate radio frequency energy and, if not installed and used in accordance with the instructions, may cause harmful interference to radio communications. However, there is no guarantee that interference will not occur in a particular installation. If this product does cause harmful interference to radio or television reception, which can be determined by turning the equipment off and on, the user is encouraged to try to correct the interference by one or more of the following measures:

- Reorient or relocate the receiving antenna.
- Increase the separation between the equipment and receiver.
- Connect the equipment into an outlet on a circuit different from that to which the receiver is connected.
- Consult the dealer or an experienced radio/TV technician for help.

FCC Conditions

This device complies with part 15 of the FCC Rules. Operation is subject to the following two conditions:

1. This device may not cause harmful interference.
2. This device must accept any interference received, including interference that may cause undesired operation.

EU CONFORMITY STATEMENT



This product and - if applicable - the supplied accessories too are marked with "CE" and comply therefore with the applicable harmonized European standards listed under the EMC Directive 2014/30/EU, the RoHS Directive 2011/65/EU



2012/19/EU (WEEE directive): Products marked with this symbol cannot be disposed of as unsorted municipal waste in the European Union. For proper recycling, return this product to your local supplier upon the purchase of equivalent new equipment, or dispose of it at designated collection points. For more information see: www.recyclethis.info



Regulation (EU) 2023/1542 (Battery Regulation): This product contains a battery and it is in conformity with the Regulation (EU) 2023/1542. The battery cannot be disposed of as unsorted municipal waste in the European Union. See the product documentation for specific battery information. The battery is marked with this symbol, which may include lettering to indicate cadmium (Cd), or lead (Pb). For proper recycling, return the battery to your supplier or to a designated collection point. For more information see: www.recyclethis.info.

INDUSTRY CANADA ICES-003 COMPLIANCE

This device meets the CAN ICES-3 (B)/NMB-3(B) standards requirements.

LIST OF CONTENTS

TITLE	PAGE
Safety Summary	5
1. GENERAL INFORMATION	7
1.1 System Description	7
1.2 Standard Components	8
1.3 Key Features	9
2. OPERATING INSTRUCTIONS	10
2.1 Basic Operations	10
2.2 Main Function	16
2.3 Client Software Introduction	26
3. MAINTENANCE	27
3.1 Maintenance	27
3.2 Troubleshooting	28
4. WARRANTY INFORMATION	29
4.1 Warranty Information and Registration	29
5. SPECIFICATIONS	31
5.1 Specifications	31

SAFETY SUMMARY

- Read and follow all instructions
- Read all warnings
- Only use the attachments/accessories specified by the manufacturer
- All service must be provided by the manufacturer

WARNING:

This product contains natural rubber latex, which may cause potentially fatal allergic reactions! If you are allergic to latex, it is important that you strictly avoid exposure to products that contain it.

WARNING AND CAUTIONS:

Transportation

- Keep the device in original or similar packaging while transporting it.
- Keep all wrappers after unpacking them for future use. In case of any failure, you will need to return the device to the factory with the original wrapper. Transportation without the original wrapper may result in damage to the device and the company shall not be responsible.
- DO NOT drop the product or subject it to physical shock. Keep the device away from magnetic interference.

Power Supply

- The input voltage for the device should meet the Limited Power Source (5 VDC, 2 A) according to IEC 62368-1 standard. Please refer to technical specifications for detailed information.
- Use the provided power adapter. Refer to the product specification for detailed power requirements.
- Make sure the plug is properly connected to the power socket.
- DO NOT connect multiple devices to one power adapter to avoid overheating and fire hazard caused by overloading.

Battery

- Improper use or replacement of the battery may result in an explosion hazard. Replace with the same or equivalent type only. The battery type is 18650 with the protection board, and the battery size should be 19 mm × 70 mm. The rated voltage and capacity are 3.6 VDC/3.35 Ah (12.06 Wh). Dispose of used batteries in conformance with the instructions provided by the battery manufacturer.
- For long-term storage of the battery, make sure it is fully charged every half year to ensure the battery quality. Otherwise, damage may occur.
- The battery cannot be charged with external power source directly.
- Do not charge other battery types with the supplied charger. Confirm there is no flammable material within 2 m of the charger during charging.
- DO NOT place the battery near heating or fire source. Avoid direct sunlight.
- DO NOT swallow the battery.
- DO NOT place the battery within the reach of children.

Maintenance

- If the product does not work properly, please contact your dealer or the nearest service center. AGM cannot assume any responsibility for problems caused by unauthorized repair or maintenance.
- Wipe the device gently with a clean cloth and a small quantity of ethanol if necessary.
- It is recommended to reboot the device every 2 hours when using it to ensure maximum performance.

Using Environment

- Make sure the ambient environment meets the requirement of the device. The operating temperature shall be -30°C to 55°C (-22°F to 131°F), and the operating humidity shall be 95% or less.
- DO NOT expose the device to extremely hot, cold, dusty, corrosive, saline-alkali, or damp environments.
- Store the device in room temperature whenever possible, as long periods of storage in extreme heat (such as inside a vehicle) may lead to issues with the display materials.
- Avoid equipment installation on vibrating surfaces or places subject to shock (neglect may cause equipment damage).
- DO NOT aim the lens at the sun or any other bright light.

EMERGENCY:

If smoke, odor, or noise arises from the device, immediately turn off the power, unplug the power cable, and contact the service center.

1 GENERAL INFORMATION

1.1 SYSTEM DESCRIPTION

The AGM TaipanV² Thermal Monocular series boasts multiple Germanium lens sizes which are paired with an industry-leading 256, 320 or 384 resolution 12-micron thermal detector. The models with 384 resolution have superior sub-20 milikelvin thermal sensitivity. The TaipanV² also bring many new advancements to the product family which users have been clamoring for in the original Taipan monoculars. These primary improvements include moving from a non-removable rechargeable internal battery to a single removable rechargeable 18650, a new thermal sensor and a new tilt sensor which powers off the display to save battery life!

The TaipanV² also comes packed with numerous software improvements, and many features that have become commonplace within the AGM thermal product assortment: F1.0 aperture optics, 50Hz refresh rate, 16GB of built-in memory, Wi-Fi compatibility to pair with the AGM Connect App, an IP67 waterproof rating, USB Type-C port for external power capabilities and 4 color palettes. They also utilize a wider rubber eyepiece to make viewing the 1024 OLED display extremely comfortable in the field when viewing for long periods of time in a single session. The TaipanV² are built for well-rounded use and would work great for hunting, farming/herd protection, law enforcement, search & rescue, boating, camping and other general outdoors activities.

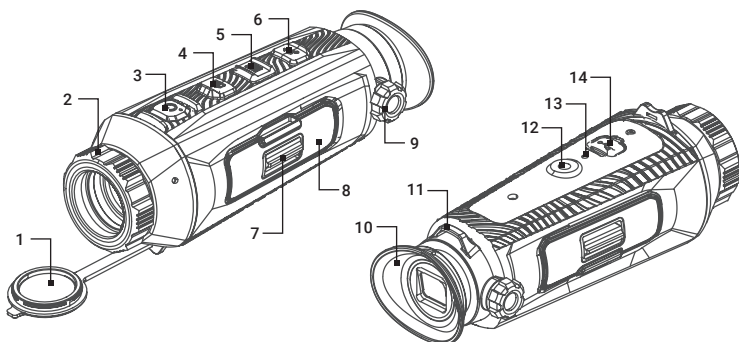

FIGURE 1-1. MAIN PARTS

TABLE 1-1. MAIN PARTS

ITEM	DESCRIPTION	ITEM	DESCRIPTION
1	Lens Cap	8	Battery Cover
2	Focus Ring	9	Diopter Adjustment Knob
3	Power Button	10	Eyepiece
4	Capture Button	11	Wrist Strap Hole
5	Menu Button	12	Tripod Socket
6	Zoom Button	13	Charging Indicator
7	Battery Cover Lock	14	USB Type-C Interface

1.2 STANDARD COMPONENTS

The standard components are shown in Figure 1-2 and listed in Table 1-2. The ITEM NO. column indicates the number used to identify items in Figure 1-2.

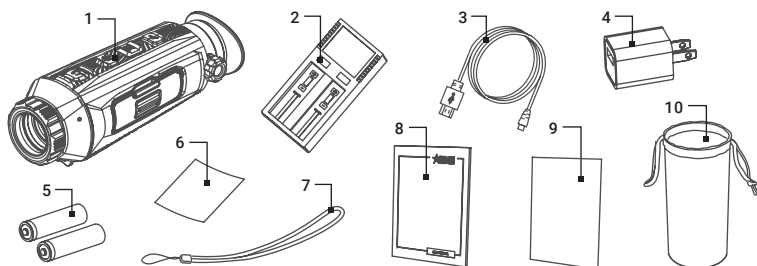

FIGURE 1-2. STANDARD COMPONENTS

TABLE 1-2. STANDARD COMPONENTS

ITEM	DESCRIPTION	QUANTITY
1	Monocular	1
2	Battery Charger	1
3	USB Cable	1
4	Power Adapter (US and EU plugs included)	1
5	18650 Rechargeable Battery	2
6	Lens Cloth	1
7	Wrist Strap	1
8	User Manual	1
9	Quick Start Guide	1
10	Protective Bag	1

1.3 KEY FEATURES

- 12-micron high-sensitivity thermal detector
- 256x192, 320x256 or 384x288 resolution
- Advanced image processing
- 50 Hz image frame rate
- High resolution display
- Quick activation in 3 seconds
- Built-in recording with sound
- 16 GB built-in memory module
- Wi-Fi hotspot
- Up to 8× digital zoom
- Replaceable and rechargeable Li-Ion battery
- Up to 7 hours of battery life (depends on the model)
- Auto Power Off and Auto Screen Off functions to save energy
- External power supply capability
- The battery can be charge either in the device or in the charger
- Rugged housing
- Waterproof

2 OPERATING INSTRUCTIONS

2.1. BASIC OPERATIONS

2.1.1 UNPACKING

The following steps must be completed before each use.

1. Open the carrying case, remove the monocular, and verify that all components are present.
2. Inspect the monocular for any obvious evidence of damage to the lenses, body, eyecup, buttons, etc. Ensure that all optical surfaces are clean and ready for use. Clean all optical surfaces with a lens tissue.

2.1.2 BATTERY INSTALLATION

1. Unlock the battery compartment cover.
2. Open the battery compartment cover.

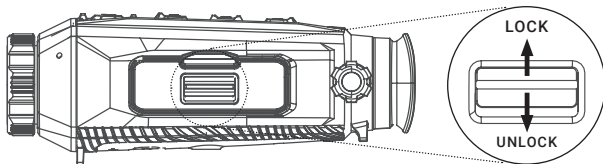

FIGURE 2-1. BATTERY COMPARTMENT

3. Insert the battery into the battery compartment as the positive and negative marks indicate.

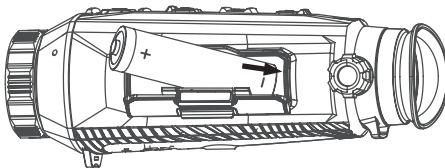

FIGURE 2-2. BATTERY INSTALLATION

4. Close the battery compartment cover and lock it.

You can charge the battery directly in the monocular using the 5V power adapter and Type-C cable, or use the included charger to charge one or two batteries.





NOTE:

Remove the battery from the battery compartment if the device is not being used for a long time.

2.1.3 CONTROLS

The TaipanV² controls are shown in Figures 2-3 and are defined in Tables 2-1. Each button performs specific functions activated either by a short press or a long press (press and hold for more than 2 seconds).

TABLE 2-1. FUNCTIONS OF CONTROL BUTTONS



BUTTON	FUNCTIONS
 POWER	Short Press: Standby mode/Wake up device Long Press: Power ON/OFF
 CAPTURE	Short Press: Capture image Long Press: Start/stop recording MENU MODE: Short Press: Move up / Increase
 MENU	Short Press: Switch palettes Long Press: Enter / Exit the menu MENU MODE: Short Press: Confirm / Set parameters Long Press: Save and exit menu
 ZOOM	Short Press: Switching digital zoom Long Press: Image calibration (FFC) MENU MODE: Short Press: Move down / Decrease

2.1.4 POWER ON AND OFF

Power On

When the charged battery is installed, hold the POWER button  to power on the device. The power indicator stays solid red when the device is on.

NOTE

See the battery icon on the device display to check the battery charge. Icon  means the battery is fully charged, and icon  means that the battery is low. When the low power note shows, charge or replace the battery.

Power Off

Hold the POWER button  to power off the device.

Auto Power Off

In the "Auto Power Off" menu (see 2.2.22) you can set the time for the automatic shutdown of the device as required (OFF / 15 min / 30 min / 45 min).

The Auto Power Off function starts countdown when Standby mode enable. The auto power off countdown is disabled when the device wakes up from standby. The countdown will be restarted when the device is put into standby mode again.

2.1.5 STANDBY MODE

In the view mode, press the POWER button . After a few seconds, the display will turn off. Press the POWER button  again to exit the Standby mode.

2.1.6 AUTO SCREEN OFF

Auto screen off function darkens the screen to save energy and increase battery time. However, the device stays on and you can view the live view on AGM Connect app when connecting the device to the app. The integrated algorithm automatically detects monocular's exact position and activates the auto screen-off function. Device will stand by automatically at a lateral tilt of 75° as well as at a downward or upward tilt of 70° (see paragraph 2.2.11 for details).

2.1.7 THERMAL VIEW OBSERVATION

1. Open the objective lens cap.
2. Power on the monocular.
3. Hold the monocular and make sure the eyepiece covers your eye.
4. Adjust the diopter by turning the knob on the side of the device until the OSD text or image is clear.
5. Point the monocular towards the target.
6. Bring the object into focus by turning the focus ring (only for models with lens focus ring).

NOTE:

You must perform the focus adjustment before any further use of the monocular.

7. For best observation effectiveness, set palette, brightness, contrast, sharpness and scene mode using the device menu.

2.1.8 ON-SCREEN DISPLAY

On-screen interface displays the main menu items and device status indicators. Hold the MENU button  in the view mode to display or hide the menu. Adjust the On-Screen Display (OSD) in Function Settings menu (see 2.2.13).

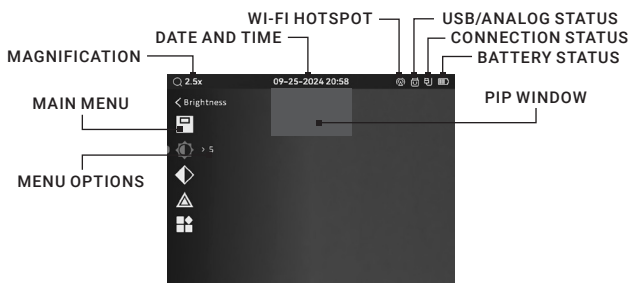

FIGURE 2-4. ON-SCREEN DISPLAY

When OSD is on, the information of Wi-Fi hotspot activation, magnification, connection status, battery status, time and date displays on the screen.

2.1.9 COLOR PALETTE SETTINGS



You can select different color palettes to display the same scene in different effects. Press the MENU button  in live view interface to switch palettes.

TABLE 2-2. COLOR PALETTES

PALETTE	DESCRIPTION
WHITE HOT	The hot part is displayed in white. The higher the temperature, the lighter the color.
BLACK HOT	The hot part is displayed in black. The higher the temperature, the darker the color.
FUSION	The hot part is displayed in white. From high temperature to low temperature, the image is colored in from white, yellow, red, pink to purple.
RED HOT	The hottest part is displayed in red, the rest of the image will be flushed out in shades of gray.

2.1.10 DIGITAL ZOOM

You can magnify the image by using the Digital Zoom function.

Press the Zoom button  in the view mode to change the magnification. The monocular has four levels of digital zoom. The current magnification value will be displayed on the screen:

- AGM TaipanV² 10-256: 1.5×, 3×, 6×, 12×
- AGM TaipanV² 15-256: 2×, 4×, 9×, 17.5×
- AGM TaipanV² 19-320: 3×, 6×, 11×, 22.5×
- AGM TaipanV² 15-384: 1.5×, 3×, 6×, 12×
- AGM TaipanV² 19-384: 2×, 4×, 8×, 16×
- AGM TaipanV² 25-384: 2.5×, 5×, 10×, 20×

2.1.11 IMAGE CALIBRATION

Hold the ZOOM button  in the view mode to release the shutter once for correction of the non-uniformity of display (see 2.2.16 for more information).

2.1.12 VIDEO RECORDING AND IMAGE CAPTURE

Video Recording

1. In the main live view, hold the CAPTURE button  and start recording.

The top left of image displays the information of recording time.

2. Hold the CAPTURE button  again to stop recording.

If you enable the audio function, the sound will be recorded with the video (see paragraph 2.2.8 for details).

Snapshot Capture

In the main live view, press the CAPTURE button  to capture picture.

NOTE:

- When capture is successful, the image freezes for 1 second and a prompt shows on the display.
- For information about exporting captured images, see File Export paragraph.

2.1.13 CONNECTING THE DEVICE

1. Open the USB interface cover.
2. Connect the device to computer using a USB-C cable to copy/delete files.
3. Connect the device and the power adapter or power bank using a USB-C cable to charge the installed 18650 rechargeable battery.

The LED indicator indicates the charging status of the device:

- **Flashing Red & Green:** Error occurred.
- **Solid Red:** Charging.
- **Solid Green:** Fully charged.

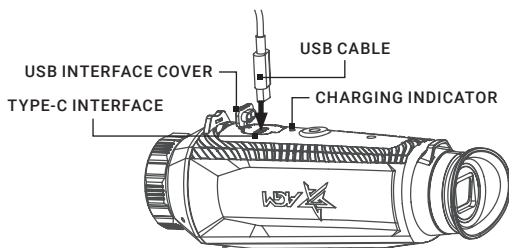















FIGURE 2-5. CABLE CONNECTION

2.1.14 EXPORT FILES VIA PC

Before connecting the thermal monocular to a computer, please make sure that the Wi-Fi function of the monocular is disabled.

1. Hold the MENU button  to show the menu.
2. Go to  **Advanced Settings**, and press  or  button to select  **Function Settings** menu and press the MENU button  to confirm.
3. Press  or  button to select  **USB Connection** submenu and press the MENU button  to enter the configuration interface.
4. Press  or  button to select **Analog** to turn on CVBS output.
5. Hold the MENU button  to exit a menu.
6. Connect the thermal monocular to your PC with USB cable and open the detected disk.

NOTE:

Make sure the device is turned on when connecting the cable

7. The directory is named by the current date. Enter DCIM > "Date" to view the videos and snapshots.
 - Select and copy the videos to PC and play the file with the player.
 - Select and copy the snapshots to PC and view the files.
8. Disconnect the device from your PC.

NOTE:

- The device displays images when you connect it to PC. But functions such as recording, capturing and hot spot are disabled.
- When you connect the device to PC for the first time, it installs the driver automatically.

2.1.15 EXPORT FILES VIA AGM CONNECT APP

You can access device albums and export files to your phone via AGM Connect App (Paragraph 2.3).

1. Open AGM Connect and connect your device to the app.
2. Tap **Media** to access device albums.
3. Tap to select a file, and tap **Download** to export the file to your local phone albums.

2.2 MAIN FUNCTIONS

2.2.1 MENU OPERATION

When the device powers on, hold the MENU button  to display the menu.

































In the menu, you can press the buttons  and  to select functions, press the button  to configure the selected function, and hold the button  to exit the menu.

TABLE 2-3. MENU FUNCTIONS

MENU ITEM	SYMBOL	OPTION	FUNCTION
PIP		OFF / ON	Enables or disables the PIP function.
BRIGHTNESS		10 Levels of Brightness	Adjusts the image brightness.
CONTRAST		10 Levels of Contrast	Adjusts the image contrast.
SHARPNESS		5 Levels of Sharpness	Adjusts the image sharpness.
ADVANCED SETTINGS		Advanced Settings Menu:	
NETWORK		Close / Hotspot	Enables or disables the Wi-Fi hotspot.
MEASURE		Target: Deer, Grey Wolf, Brown Bear, and Custom	Measures the distance between the target and the observation position.
HOT TRACKING		OFF / ON	Enables or disables hot spot mark (marking the spot of highest temperature).
AUDIO		OFF / ON	Enable or disable Audio.
TONE		Cold / Warm	Switch between the Cold mode and Warm mode.
AUTO SCREEN OFF		OFF / ON	Function darkens the screen to save energy
SCENE MODE		General / Compressed	Switch between the General mode and Compressed mode.
FUNCTION SETTINGS		Function Settings Menu:	
OSD		OSD / Time / Date	Enables or disables OSD, time, date.
Brand Logo		OFF / ON	ON/OFF AGM logo in the lower left corner of the screen.

MENU ITEM	SYMBOL	OPTION	FUNCTION
USB Connection		USB Flash Drive/ Analog	Enables an analog connection to turn on the CVBS output.
Image Calib.		Auto / Semi-Auto / Manual	Selecting the Flat Field Correction (FFC) mode.
DPC		Axis: N/X/Y	Correction of dead pixel manually.
Burn Prevention		OFF / ON	Enables or disables the Burn Prevention function.
GENERAL SETTINGS		General Settings Menu:	
Language		26 Languages	Choice of interface language.
Date		Month/Day/Year	Date setting.
Time		12 / 24 hour	Time setting.
Unit		yd / m	Sets the distance unit.
Auto Power Off		OFF / 15 min / 30min / 45min	Setting the automatic shutdown time.
Reboot		---	Reset the basic settings: Brightness, Contrast, PIP, etc.
Restore Factory Settings		---	Restoring the default device settings and erase all internal storage content.
Diagnostic Log		---	Using for recording device status and troubleshooting.
Version		---	Firmware version, serial number and free space of built-in storage.

2.2.2 PICTURE IN PICTURE MODE









The Picture-in-Picture (PIP) mode allows you to see simultaneously both a magnified image of the central part in a PIP window and the main image. The PIP window is displayed at the up-center of the live view.

1. Hold the MENU button  to go to the **Menu**.
2. Press  or  button to select  **PIP** menu item and press the button  to enable or disable **Picture-In-Picture** mode.









The PIP window show in the upper part of screen. When the PIP is on, use the ZOOM button to change the magnification in the PIP window. The main screen magnification will not change at this time. The current PIP magnification value will be shown in the PIP window for 3 seconds.

3. Hold the MENU button  to exit a menu.

2.2.3 BRIGHTNESS ADJUSTMENT









1. Hold the MENU button  to go to the **Menu**.
2. Press  or  button to select  **Brightness** menu item and press the MENU button  to confirm.
3. Press  or  button to adjust the brightness. You can select one of ten levels of the brightness to adjust the image lighter or darker.
4. Press the MENU button  to confirm.

2.2.4 CONTRAST ADJUSTMENT

1. Hold the MENU button  to go to the **Menu**.
2. Press  or  button to select  **Contrast** menu item and press the MENU button  to confirm.
3. Press  or  button to adjust the image contrast. You can select one of ten levels of the contrast.
4. Press the MENU button  to confirm.







2.2.5 SHARPNESS SETTING

This function allows you to adjust the sharpness of the thermal image.

1. Hold the MENU button  to go to the **Menu**.
2. Press  or  button to select  **Sharpness** menu item and press the MENU button  to confirm.
3. Press  or  button to adjust the image sharpness.
4. Press the MENU button  to confirm.

2.2.6 NETWORK CONFIGURATION

Connect your phone to the Wi-Fi hotspot of the monocular, you can configure the parameters and realize functions of the device.

1. Hold the MENU button  to show the menu.
2. Go to  **Advanced Settings**, and press  or  to Select the  **Network** menu item and press the MENU button  to enable or disable Wi-Fi hotspot.
3. Hold the MENU button  to exit a menu.

Open the AGM Connect APP and connect your phone with the device (refer to Section 2.3). You can view the interface of monocular on your phone.

NOTE:

When the power is less than 15%, the Wi-Fi hotspot function will be turned off automatically.

2.2.7 DISTANCE MEASUREMENT

NOTE:

When measuring the distance, keep your hand and the position steady. Otherwise, the accuracy may be affected.

The device can measure the distance between the target and the observer's position.

1. Hold the MENU button  to show the menu.

- Go to **Advanced Settings**, and press **[P±]** or **[📷]** button to select **Measure** menu item and press the MENU button **[☰]** to enter the distance measurement mode.
- Press **[P±]** button to enter the target setting interface.
 - Press **[P±]** or **[📷]** to select the target from Wolf, Bear, Deer, and Custom.
 - Press the MENU button **[☰]** to set the target height. Press **[P±]** or **[📷]** buttons to change the number. Each target height preset can be modified from 0.1 to 9.9 m. Press the MENU button **[☰]** to confirm.
 - Hold the MENU button **[☰]** to exit target setting.
- Align the center of the top mark with the top edge of the target. Press the MENU button **[☰]**. The top mark blinks and then changes to the bottom mark.
- Align the center of the bottom mark with the bottom edge of the target. Press the MENU button **[☰]**. The bottom mark blinks and then disappears.
- The right top of the image displays the distance measurement result and the height of the target.



FIGURE 2-6. DISTANCE MEASUREMENT

NOTE:

Go to distance measurement interface, and press **[☰]** button to view the result of the previous measuring target.

2.2.8 HOT TRACKING

The device can detect the highest temperature spot in the scene and mark it on display.

- Hold the MENU button **[☰]** to show the menu.
- Go to **Advanced Settings**, and press **[P±]** or **[📷]** button to select **Hot Tracking** menu item and press the MENU button **[☰]** to enable/disable hot spot mark (marking the spot of highest temperature).
- Hold the MENU button **[☰]** to exit a menu.

When the hot spot mark is enabled, the green cross mark **-|-** displays in the spot of the highest temperature. When the scene changes, the green mark moves.









2.2.9 AUDIO RECORDING SETTING

The Audio function allows you to record sound along with video. If there is too much noise when recording, this function can be disabled.

- Hold the MENU button **[☰]** to show the menu.
- Go to **Advanced Settings**, and press **[P±]** or **[📷]** button to select **Audio** menu item, and press the MENU button **[☰]** to enable or disable this function.
- Hold the MENU button **[☰]** to exit a menu.









2.2.10 IMAGE TONE SETTING

This function allows you to change the tone of thermal image to warm or cold.

1. Hold the MENU button  to show the menu.
2. Go to  **Advanced Settings**, and press  or  button to select  **Tone** menu item and press the MENU button  to confirm.
3. Press  or  button to select Warm or Cold tone.
4. Hold the MENU button  to exit a menu.

2.2.11 AUTO SCREEN OFF

Auto screen off function darkens the screen to save energy and increase battery time. However, the device stays on and you can view the live view on AGM Connect app when connecting the device to the app.

1. Hold the MENU button  to show the menu.
2. Go to  **Advanced Settings**, and press  or  button to select  **Auto Screen Off** menu item and press the MENU button  to confirm.
3. Press  to enable or disable Auto Screen Off function.
4. Hold  to save settings and exit.

You can do one of the following methods to enter the standby mode when the display is turned on:









- Tilt the device downwards more than 70°.
- Rotate the device horizontally more than 75°.
- Keep the device still and do not move it for 5 minutes.

You can do one of the following methods to wake up the device when the display is turned off:

- Tilt the device downwards from 0° to 60° or upwards .
- Rotate the device horizontally from 0° to 75°.
- Press  to wake up the device.















2.2.12 SCENE MODE

You can select proper Scene Mode according to environment temperature to improve the display effect.

1. Hold the MENU button  to show the menu.
2. Go to  **Advanced Settings**, and press  or  button to select  **Scene Mode** menu item and press the MENU button  to confirm.
3. Press  or  button to switch scene mode:
General mode: improves an image so that the object edge is more distinct.
Compressed mode: is more suitable for hunting environment because of the highlight function of small objects.
4. Hold the MENU button  to exit a menu.









2.2.13 ON-SCREEN DISPLAY (OSD)

You can choose which OSD information to display in the live view user interface. Options include, wi-fi hotspot activation, current magnification, memory storage status, battery indicator status, time and date. These will appear at the top of the display interface when activated.

1. Hold the MENU button  to show the menu.
2. Go to  **Advanced Settings**, and press  or  button to select  **Function Settings** menu and press the MENU button  to confirm.
3. Press  or  button to select  **OSD** submenu and press the MENU button  to enter.
4. Press  or  button to select the **OSD, Time or Date**. Press the MENU button  to display or hide the necessary information.
5. Hold the MENU button  to exit a menu.













2.2.14 BRAND LOGO

You can display the AGM logo in the lower left corner of the screen.

1. Hold the MENU button  to show the menu.
2. Go to  **Advanced Settings**, and press  or  button to select  **Brand Logo** menu item. Press the MENU button  to enable/disable logo.
3. Press  or  to select other item or hold the MENU button  to exit a menu.

2.2.15 USB CONNECTION

The USB port can be used to transfer data to a PC, charge the installed battery, or watch video on a CVBS monitor.

1. Hold the MENU button  to show the menu.
2. Go to  **Advanced Settings**, and press  or  button to select  **Function Settings** menu and press the MENU button  to confirm.
3. Press  or  button to select  **USB Connection** submenu and press the MENU button  to enter the configuration interface.
4. Press  or  button to select **USB Flash Drive** for transfer data or charge the battery or **Analog** to turn on CVBS output.
5. Hold the MENU button  to exit a menu.

You can view the video on CVBS monitor, to get a better and clear image, more convenient to check the detail.

NOTE:

CVBS Output function doesn't support hot plug, so please connect the cable before powering on.

Connect the USB-CVBS cable to USB port of thermal device and to monitor's CVBS port. Select **Analog** mode in the USB Connection menu.













NOTE:

USB-CVBS cable need to be purchase separately.

2.2.16 IMAGE CALIBRATION

The image calibration function performs what is known as the Flat Field Correction or FFC. This is required of all thermal devices. This can correct for non-uniformity of the display. During correction an internal shutter will be lowered in front of the thermal detector. A "click" sound will often be heard, and the image is momentarily interrupted for a split second. After this quick process the detector will be re-calibrated, and the image becomes more accurate. AGM

recommends automatic when scanning for game or targets. However, we recommend going into the menu and changing to Manual correction mode to prevent any unwanted auto-correction when tracking a live game.

1. Hold the MENU button  to show the menu.
2. Go to  **Advanced Settings**, and press  or  button to select  **Function Settings** menu and press the MENU button  to confirm.
3. Press  or  button to select  **Image Calib.** submenu and press the MENU button  to enter.
4. Press  or  button to switch the FFC mode.

Auto: The monocular performs FFC automatically when switching on or rebooting the camera.

Semi-Auto: Hold the ZOOM button  in live view to correct the non-uniformity of display.

















Manual: Cover the lens cap, then hold the ZOOM button  in live view to correct the non-uniformity of display.

5. Hold the MENU button  to exit a menu.

2.2.17 DEFECTIVE PIXELS CORRECTION







The Defective Pixel Correction (DPC) can help users repair the occasional deactivated pixel within the display. This is fairly common in thermal optics, which is why so many of these optics come equipped with a DPC feature. 1-3 dead pixels are usually easily repaired by the user. Anything over 3 that cannot be repaired, will open the unit up to an approved warranty repair by AGM at their facility.

Before you start switch the palette to White Hot mode.

1. Hold the MENU button  to show the menu.
2. Go to  **Advanced Settings**, and press  or  button to select  **Function Settings** menu and press the MENU button  to confirm.
3. Press  or  button to select  **DPC** submenu and press the MENU button  to enter.
4. Press  or  button to select the X or Y axis and press the MENU button  to confirm.
5. Press  or  button to set the coordinates until the cursor reaches the dead pixel.
6. Press the MENU button  to correct the dead pixel.
7. (Optional) Repeat 4 to 6 to correct the position for other dead pixels.
8. Hold the MENU button  to exit a menu.

2.2.18 BURN PREVENTION

This function can prevent damage to the thermal sensor from the sun or other high temperature bright light sources. When enabling this function, the shield will close until the environment turns to normal. This feature may be useful to help protect sensitive sensor during extreme summer temperatures.

1. Hold the MENU button  to show the menu.
2. Go to  **Advanced Settings**, and press  or  button to select  **Function Settings** menu and press the MENU button  to confirm.

3. Press or button to select **Burn Prevention** submenu and press the MENU button to enable or disable the Burn Prevention function.
4. Hold the MENU button to exit a menu.

2.2.19 LANGUAGE SETTING

You can select different languages of user interface.

1. Hold the MENU button to show the menu.
2. Go to **Advanced Settings**, and press or button to select **General Settings** and press the MENU button to confirm.
3. Press or button to select **Language** submenu and press the MENU button to enter.
4. Press or button to select the language as required and press the MENU button to confirm.
5. Hold the MENU button to exit a menu.

2.2.20 DATE SETTING

1. Hold the MENU button to show the menu.
2. Go to **Advanced Settings**, and press or button to select **General Settings** and press the MENU button to confirm.
3. Press or button to select **Date** submenu and press the MENU button to enter the configuration interface.
4. Press the MENU button to select the month, day or year to be synchronized and press or button to change the number, then press the MENU button again to finish the setting.
5. Hold the MENU button to exit a menu.

2.2.21 TIME SETTING

1. Hold the MENU button to show the menu.
2. Go to **Advanced Settings**, and press or button to select **General Settings** and press the MENU button to confirm.
3. Press or button to select **Time** submenu and press the MENU button to enter the configuration interface.
4. Press the MENU button to select the hour, minute, second to be synchronized and press or button to change the number, then press the MENU button again to finish the setting.
5. Hold the MENU button to exit a menu.















2.2.22 UNIT SETTING

You can set the unit (yards or meters) of measurement for distance.

1. Hold the MENU button to show the menu.
2. Go to **Advanced Settings**, and press or button to select **General Settings** and press the MENU button to confirm.
3. Press or button to select **Unit** submenu and press the MENU button to enter the configuration interface.
4. Press the MENU button to select **yd** (yards) or **m** (meters).
5. Hold the MENU button to exit a menu.









2.2.23 AUTO POWER OFF

You can set the time for the automatic shutdown of the device as required.

1. Hold the MENU button  to show the menu.
2. Go to  **Advanced Settings**, and press  or  button to select  **General Settings** and press the MENU button  to confirm.
3. Press  or  button to select  **Auto Power Off** submenu and press the MENU button  to enter the configuration interface.
4. Press  or  button to select OFF, 15 min, 30 min or 45 min and press the MENU button  to confirm.
5. Hold the MENU button  to exit a menu.









2.2.24 REBOOT

You can reset all the basic settings (Brightness, Contrast, Sharpness, PIP, etc.) to default values.

1. Hold the MENU button  to show the menu.
2. Press  or  button to select  **General Settings** and press the MENU button  to confirm.
3. Press  or  button to select  **Reboot** and press the MENU button . The window “Reset the basic settings” will appear.
 - **OK**: Restore the basic settings to defaults.
 - **CANCEL**: Exit without changing the settings.











2.2.25 RESTORE FACTORY SETTINGS

You can erase all content in the built-in storage and reset device to its default settings.

1. Hold the MENU button  to show the menu.
2. Press  or  button to select  **General Settings** and press the MENU button  to confirm.
3. Press  or  button to select  **Restore Factory Settings** and press the MENU button . The window “Erase all content and settings” will appear.
 - **OK**: Erase all content and restore all settings to defaults.
 - **CANCEL**: Exit without changing the settings.











2.2.26 DIAGNOSTIC LOG

Diagnostic Log using for recording device status and troubleshooting. You can find the log files in the *log* folder in the device memory and send them to the support service if necessary (see paragraph 2.1.13 about exporting files).

1. Hold the MENU button  to show the menu.
2. Press  or  button to select  **General Settings** and press the MENU button  to confirm.
3. Press  or  button to select  **Diagnostic Log** and press the MENU button . A confirmation window will appear.
4. Select **OK** and press the MENU button  to start recording the log.

2.2.27 VERSION

You can view the device information such as firmware version, serial number and free space of built-in storage.

1. Hold the MENU button  to show the menu.
2. Go to  **Advanced Settings**, and press  or  button to select  **General Settings** and press the MENU button  to confirm.
3. Press  or  button to select  **Version** item and press the MENU button  to confirm. The firmware version, serial number and memory capacity will be displayed.

2.3 CLIENT SOFTWARE INTRODUCTION



Search the AGM Connect software in App Store (iOS System) or Google Play™ (Android System) and install the application on your mobile phone. Turn on the Wi-Fi hotspot on the thermal device and then connect your phone to the hotspot.

- Hotspot Name: Wlan-<Serial No.>

- Hotspot Password: Last 9 digits of Serial Number of your thermal device.

NOTE:

The device password is set by user at first activation. If the password was lost or forgotten, it can be reset. To reset a password perform the following steps:

1. When the thermal device is turned on, hold the MENU button  to activate the Main menu.
2. Select  Restore item in the General Settings menu and press the MENU button  to restore all parameters to default settings.

1. Run the app and connect the phone or tablet with the device.
2. If the device is inactivated, set the password and activate it. If the device is activated, enter the password to add it to the app.
3. When the device is added, the live view can be seen. You can view the interface of the device on the software. User can change such image parameters as brightness, contrast, zoom, palettes directly via phone or tablet as well as record video on phone/tablet memory.

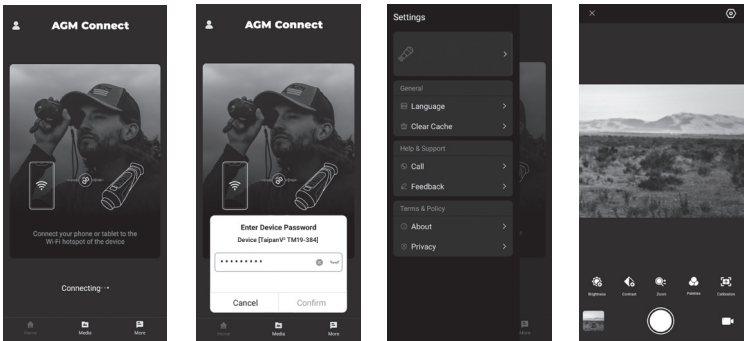

FIGURE 2-7. AGM CONNECT APPLICATION

3 MAINTENANCE

3.1 MAINTENANCE

3.1.1 CLEANING PROCEDURES

1. Gently brush off any dirt from the body of the device using a clean, soft cloth.
2. Moisten the cloth with fresh water and gently wipe down the external surfaces (except lenses).
3. Dry any wet surfaces (except lenses) using another dry, clean, soft cloth.
4. Using a lens brush, carefully remove all loose dirt from the lenses.
5. Dampen a cotton swab with ethanol and slowly, gently wipe down the lenses. Clean the glass surfaces using circular movements, starting from the center of the lens and moving out towards the edge, without touching the lens holder. Change the cotton swab after each circular stroke. Repeat this step until the glass surfaces are clean.
6. Clean the accessories with a soft brush (or cloth) dampened with soap and water.

3.1.2 PREPARING FOR EXTENDED STORAGE













CAUTION:

Thoroughly dry each item before placing them into the storage case.

To prepare the monocular for extended storage:

1. Clean the monocular and accessories.
2. Place all items into the storage case.
3. Make sure to remove the battery from the unit.

3.1.3 UPDATING THE DEVICE FIRMWARE

1. Visit www.agmglobalvision.com/firmware website. Select your product, download the firmware update package to your PC and unzip it. Follow the detailed instructions on the website.
2. Hold the MENU button  to show the menu.
3. Go to  **Advanced Settings**, and press  or  button to select  **Function Settings** menu and press the MENU button  to confirm.
4. Press  or  button to select  **USB Connection** submenu and press the MENU button  to enter.
5. Press  or  button to select **USB Flash Drive**.
6. Hold the MENU button  to exit a menu.

7. Connect the thermal device to your PC with USB cable.
8. Turn on the thermal device. Make sure the Wi-Fi hotspot function is disabled.
9. Open the detected disk (USB drive) in file manager program. Copy the unzipped digicap.dav file and paste it to the root directory of the device.
10. Turn off the device completely, then power it back on. After awhile, the firmware update process will start automatically. During the update, the screen will display the inscription "Upgrading...". The update process will be completed when the inscription "Upgrading..." goes out.
11. Repeat steps 9-10 for each updating file.
12. Turn off the device and disconnect it from your PC.

You can also use automatic update function in AGM Connect App.

3.2 TROUBLESHOOTING

Table 3-1 lists the most common malfunctions that may occur with your equipment. Perform the tests, inspections, and corrective actions in the order they appear in the table.

This table does not list all the malfunctions that may occur with your device, or all of the tests, inspections, and corrective actions that may be necessary to fix them. If the equipment malfunction is not corrected by the suggested actions, or a problem occurs that is not listed in this table, please contact AGM Global Vision's Customer Support center or your retailer.

TABLE 3-1. TROUBLESHOOTING

MALFUNCTION	CORRECTIVE ACTION
The monocular fails to activate.	<ol style="list-style-type: none"> 1. Battery is missing or improperly installed. Insert battery or install correctly. 2. Battery are dead. Replace the battery. 3. Battery, surfaces or contacts are dirty or corroded. Clean the contact.
The image is not clear.	Perform the monocular focus adjustment referring to section 2.1.6.
Wi-Fi is not found.	Examine whether the Wi-Fi function is turned on. If not, go to OSD menu and turn on Wi-Fi.
Capture or recording failed.	Examine the items below: <ol style="list-style-type: none"> 1. Whether the device is connected to your PC and the capture and recording features are disabled. 2. Whether the storage space is full. 3. Whether the device has a low-battery condition.
The PC cannot identify the monocular.	Examine the items below: <ol style="list-style-type: none"> 1. Whether the device is connected to your PC with standard USB cable. 2. If you use other USB cables, make sure the cable length is no longer than 1 m (3.3 ft).

4 WARRANTY INFORMATION

4.1 WARRANTY INFORMATION AND REGISTRATION

The below description of AGM Global Vision warranty terms and conditions refer specifically to AGM branded products purchased within the United States. Customers purchasing AGM products outside the United States can obtain specific information about their product's warranty term on the www.agmglobalvision.eu website.

4.1.1 WARRANTY INFORMATION

This product is guaranteed to be free from manufacturing defects in material and workmanship under normal use for a period of five (5) years from the date of purchase. In the event that a defect covered by the warranty below occurs during the applicable period stated above, AGM Global Vision, at its discretion, will either repair or replace the product; such action on the part of AGM Global Vision shall be the full extent of AGM Global Vision's liability, and the Customer's sole and exclusive reparation. This warranty does not cover a product if it has been (a) used in ways other than its normal and customary manner; (b) subjected to misuse; (c) subjected to alterations, modifications or repairs by the Customer or by any party other than AGM Global Vision without prior written consent of AGM Global Vision; (d) is the result of a special order or categorized as "close-out" merchandise or merchandise sold "as-is" by either AGM Global Vision or the AGM Global Vision dealer; or (e) merchandise that has been discontinued by the manufacturer and either parts or replacement units are not available due to reasons beyond the control of AGM Global Vision. AGM Global Vision shall not be responsible for any defects or damage that in AGM Global Vision's view are a result from the mishandling, abuse, misuse, improper storage or improper operation of the device, including use in conjunction with equipment that is electrically or mechanically incompatible with, or of inferior quality to, the product, as well as failure to maintain the environmental conditions specified by the manufacturer. This warranty is extended only to the original purchaser. Any breach of this warranty shall be enforced unless the customer notifies AGM Global Vision at the address noted below within the applicable warranty period.

The customer understands and agrees that except for the foregoing warranty, no other warranties written or oral, statutory, expressed or implied, including any implied warranty of merchantability or fitness for a particular purpose, shall apply to the product. All such implied warranties are hereby and expressly disclaimed.

4.1.2 LIMITATION OF LIABILITY

AGM Global Vision will not be liable for any claims, actions, suits, proceedings, costs, expenses, damages, or liabilities arising out of the use of this product. Operation and use of the product are the sole responsibility of the Customer. AGM Global Vision's sole undertaking is limited to providing the products and services outlined herein in accordance with the terms and conditions of

this Agreement. The provision of products sold and services performed by AGM Global Vision to the Customer shall not be interpreted, construed, or regarded, either expressly or implied, as being for the benefit of or creating any obligation toward any third party of legal entity outside AGM Global Vision and the Customer; AGM Global Vision's obligations under this Agreement extend solely to the Customer. AGM Global Vision's liability hereunder for damages, regardless of the form or action, shall not exceed the fees or other charges paid to AGM Global Vision by the customer or customer's dealer. AGM Global Vision shall not, in any event, be liable for special, indirect, incidental, or consequential damages, including, but not limited to, lost income, lost revenue, or lost profit, whether such damages were foreseeable or not at the time of purchase, and whether or not such damages arise out of a breach of warranty, a breach of agreement, negligence, strict liability, or any other theory of liability.

4.1.3 PRODUCT REGISTRATION

In order to validate the warranty on your product, the customer must complete and submit AGM Global Vision PRODUCT REGISTRATION FORM on our website (www.agmglobalvision.com/customer-support).

4.1.4 OBTAINING WARRANTY SERVICE

To obtain warranty service on your unit, the End-user (Customer) must notify the AGM Global Vision service department via e-mail. Send any requests to support@agmglobalvision.com to receive a Return Merchandise Authorization number (RMA). When returning any device, please take the product to your retailer, or send the product, postage paid and with a copy of your sales receipt, to AGM Global Vision's service center at the address listed above. All merchandise must be fully insured with the correct postage; AGM Global Vision will not be responsible for improper postage or merchandise that becomes lost or damaged during shipment. When sending product back, please clearly write the RMA# on the outside of the shipping box. Please include a letter that indicates your RMA#, the Customer's Name, a Return Address, reason for the return, contact information (valid telephone numbers and/or an e-mail address), and proof of purchase that will help us to establish the valid start date of the warranty. Product merchandise returns that do not have an RMA# listed may be refused, or a significant delay in processing may occur. Estimated Warranty service time is 10-20 business days. The End-user/Customer is responsible for postage to AGM Global Vision for warranty service. AGM Global Vision will cover return postage/shipping after warranty repair to the End-user/Customer only if the product is covered by the aforementioned warranty. AGM Global Vision will return the product after warranty service by domestic UPS Ground service and/or domestic mail. Should any other requested, required, or international shipping methods be necessary, the postage/shipping fee will be the responsibility of the End-user/Customer.

For service, repair or replacement, please contact:

AGM Global Vision, LLC

173 West Main Street

PO Box 962

Springerville, AZ 85938

Tel. 928.333.4300

support@agmglobalvision.com

www.agmglobalvision.com

5 SPECIFICATIONS

5.1 SPECIFICATIONS

MODEL	TAIPAN V ² 10-256	TAIPAN V ² 15-256	TAIPAN V ² 19-320
Detector Type	12 μ m Vanadium Oxide Uncooled Focal Plane Array	12 μ m Vanadium Oxide Uncooled Focal Plane Array	12 μ m Vanadium Oxide Uncooled Focal Plane Array
Resolution	256 \times 192	256 \times 192	320 \times 256
Refresh Rate	50 Hz	50 Hz	50 Hz
Response Waveband	8 μ m to 14 μ m	8 μ m to 14 μ m	8 μ m to 14 μ m
NETD	\leq 35 mk (@25°C), F#=1.0	\leq 35 mk (@25°C), F#=1.0	\leq 35 mk (@25°C), F#=1.0
Detection Range (6' object)	500 m	750 m	950 m
Lens System	10 mm; F1.0	15 mm; F1.0	19 mm; F1.0
Exit Pupil	6 mm	6 mm	6 mm
Eye Relief	20 mm	20 mm	20 mm
Field of View (H \times V)	17.5° \times 13.1°	11.7° \times 8.8°	9.2° \times 6.9°
Magnification	1.5 \times / 3 \times / 6 \times / 12 \times	2 \times / 4 \times / 9 \times / 17.5 \times	3 \times / 6 \times / 11 \times / 22.5 \times
Focus Mode	Fixed Focus	Fixed Focus	Focus Ring
Min. Focusing Distance	1 m	1.5 m	1.9 m
Diopter Adjustment	-4 to +4 dpt	-4 to +4 dpt	-4 to +4 dpt
Monitor	1280 \times 960, 0.4 in, LCOS	1280 \times 960, 0.4 in, LCOS	1280 \times 960, 0.4 in, LCOS
FFC (Flat Field Correction)	Auto, Semi-Auto, Manual	Auto, Semi-Auto, Manual	Auto, Semi-Auto, Manual
Palettes	Black Hot, White Hot, Red Hot, Fusion	Black Hot, White Hot, Red Hot, Fusion	Black Hot, White Hot, Red Hot, Fusion
Scene Mode	General / Compressed	General / Compressed	General / Compressed

MODEL	TAIPAN V ² 10-256	TAIPAN V ² 15-256	TAIPAN V ² 19-320
Brightness Adjustment	10 levels	10 levels	10 levels
Contrast Adjustment	10 levels	10 levels	10 levels
Tone Adjustment	Cold, Warm	Cold, Warm	Cold, Warm
Highest Temperature Spot Tracking	Yes	Yes	Yes
Wi-Fi Hotspot	Yes	Yes	Yes
Standby Mode	Yes	Yes	Yes
Picture-In-Picture Mode	Yes	Yes	Yes
Distance Measurement	Stadiametric Rangefinder	Stadiametric Rangefinder	Stadiametric Rangefinder
Storage	Built-in memory (16 GB)	Built-in memory (16 GB)	Built-in memory (16 GB)
Video/Audio Recording	Yes / Yes	Yes / Yes	Yes / Yes
Image Capture	Yes	Yes	Yes
Battery Type	One 18650 Replaceable rechargeable Lithium battery	One 18650 Replaceable rechargeable Lithium battery	One 18650 Replaceable rechargeable Lithium battery
Battery Operating Time	Up to 7 hours	Up to 7 hours	Up to 6 hours
Power	5 VDC/2 A, 1.75 W	5 VDC/2 A, 1.75 W	5 VDC/2 A, 1.75 W
Interface	USB Type-C	USB Type-C	USB Type-C
Working Temperature	-30°C to 55°C (-22°F to 131°F)	-30°C to 55°C (-22°F to 131°F)	-30°C to 55°C (-22°F to 131°F)
Protection Level	IP67 (Waterproof)	IP67 (Waterproof)	IP67 (Waterproof)
Dimensions	165 × 60 × 64 mm (6.3 × 2.4 × 2.5 in)	165 × 60 × 64 mm (6.3 × 2.4 × 2.5 in)	173 × 60 × 64 mm (6.8 × 2.4 × 2.5 in)
Weight	0.27 kg (0.6 lb)	0.28 kg (0.61 lb)	0.3 kg (0.66 lb)

MODEL	TAIPAN V ² 15-384	TAIPAN V ² 19-384	TAIPAN V ² 25-384
Detector Type	12μm Vanadium Oxide Uncooled Focal Plane Array	12μm Vanadium Oxide Uncooled Focal Plane Array	12μm Vanadium Oxide Uncooled Focal Plane Array
Resolution	384×288	384×288	384×288
Refresh Rate	50 Hz	50 Hz	50 Hz
Response Waveband	8μm to 14μm	8μm to 14μm	8μm to 14μm
NETD	≤ 20 mk (@25°C), F#=1.0	≤ 20 mk (@25°C), F#=1.0	≤ 20 mk (@25°C), F#=1.0
Detection Range (6' object)	750 m	950 m	1200 m
Lens System	15 mm; F1.0	19 mm; F1.0	25 mm; F1.0
Exit Pupil	6 mm	6 mm	6 mm
Eye Relief	20 mm	20 mm	20 mm
Field of View (H×V)	17.5° × 13.1°	13.7° × 10.3°	10.5° × 7.9°
Magnification	1.5× / 3× / 6× / 12×	2× / 4× / 8× / 16×	2.5× / 5× / 10× / 20×
Focus Mode	Fixed Focus	Focus Ring	Focus Ring
Min. Focusing Distance	1.5 m	1.9 m	2.5 m
Diopter Adjustment	-5 to +3 dpt	-5 to +3 dpt	-5 to +3 dpt
Monitor	1024×768, 0.39in, OLED	1024×768, 0.39in, OLED	1024×768, 0.39in, OLED
FFC (Flat Field Correction)	Auto, Semi-Auto, Manual	Auto, Semi-Auto, Manual	Auto, Semi-Auto, Manual
Palettes	Black Hot, White Hot, Red Hot, Fusion	Black Hot, White Hot, Red Hot, Fusion	Black Hot, White Hot, Red Hot, Fusion
Scene Mode	General / Compressed	General / Compressed	General / Compressed
Brightness Adjustment	10 levels	10 levels	10 levels
Contrast Adjustment	10 levels	10 levels	10 levels
Tone Adjustment	Cold, Warm	Cold, Warm	Cold, Warm
Highest Temperature Spot Tracking	Yes	Yes	Yes
Wi-Fi Hotspot	Yes	Yes	Yes

MODEL	TAIPAN V ² 15-384	TAIPAN V ² 19-384	TAIPAN V ² 25-384
Standby Mode	Yes	Yes	Yes
Picture-In-Picture Mode	Yes	Yes	Yes
Distance Measurement	Stadiametric Rangefinder	Stadiametric Rangefinder	Stadiametric Rangefinder
Storage	Built-in memory (16 GB)	Built-in memory (16 GB)	Built-in memory (16 GB)
Video/Audio Recording	Yes / Yes	Yes / Yes	Yes / Yes
Image Capture	Yes	Yes	Yes
Battery Type	One 18650 Replaceable rechargeable Lithium battery	One 18650 Replaceable rechargeable Lithium battery	One 18650 Replaceable rechargeable Lithium battery
Battery Operating Time	Over 6.5 hours	Over 6.5 hours	Over 6.5 hours
Power	5 VDC/2 A, 1.75 W	5 VDC/2 A, 1.75 W	5 VDC/2 A, 1.75 W
Interface	USB Type-C	USB Type-C	USB Type-C
Working Temperature	-30°C to 55°C (-22°F to 131°F)	-30°C to 55°C (-22°F to 131°F)	-30°C to 55°C (-22°F to 131°F)
Protection Level	IP67 (Waterproof)	IP67 (Waterproof)	IP67 (Waterproof)
Dimensions	165 × 60 × 64 mm (6.3 × 2.4 × 2.5 in)	173 × 60 × 64 mm (6.8 × 2.4 × 2.5 in)	173 × 60 × 64 mm (6.8 × 2.4 × 2.5 in)
Weight	0.3 kg (0.66 lb)	0.31 kg (0.68 lb)	0.31 kg (0.68 lb)

**All data is subject to change without notice.*



AGM Global Vision, LLC

MAIN OFFICE

173 West Main Street

PO Box 962

Springerville, AZ 85938

USA

Tel. +1.928.333.4300

info@agmglobalvision.com

www.agmglobalvision.com

EUROPEAN OFFICE

#6 Andrey Lyapchev Blvd

Sofia, P.C. 1756

Bulgaria

Tel. +35.988.560.0326

info@agmglobalvision.eu

www.agmglobalvision.eu

DOWNLOAD AGM CONNECT APP:



Google Play Store



Apple App Store

AGMglobalvision.com